



**QUALIFICATION OF DACROMET® FOR USE WITH ASTM A490 HIGH-
STRENGTH STRUCTURAL BOLTS**

AN INVESTIGATION PER IFI-144

by

Salim Brahim Eng.

IBECA Technologies Corp.

Montreal, Quebec

CANADA

FINAL
December 13, 2006

EXECUTIVE SUMMARY

ASTM A490 currently prohibits the application of metallic coatings on its high strength structural bolts. At the heart of this prohibition was the desire to institute a measure that would eliminate the risk of hydrogen embrittlement. The long term objective of this investigation was to make a case for allowing the application of a “safe” metallic coating on high strength structural fasteners. To achieve this, the methodology prescribed in IFI-144 was applied to qualify the DACROMET® coating system for use with ASTM A490 bolts. DACROMET® satisfied all of the performance criteria specified in IFI-144, including paintability, coating adhesion, and rotational capacity. Continuous salt spray and cyclic exposure demonstrated that DACROMET® has significantly superior corrosion protection capabilities in comparison with hot dip galvanizing and mechanical galvanizing. Process qualification results and product testing results demonstrated that DACROMET® does not cause internal hydrogen embrittlement (IHE), nor does it promote environmental hydrogen embrittlement (EHE) when used on ASTM A490 bolts. Finally, the investigation demonstrated that IFI-144 can serve as an effective testing roadmap for qualifying metallic coatings for use with high strength structural fasteners.

This report is primarily intended for review by ASTM Committee F16 on Fasteners and the Research Council on Structural Connections (RCSC), with the aim of providing the necessary data for both bodies to (i) consider approving DACROMET® for use on ASTM A490 high strength structural bolts, and (ii) endorse IFI-144 as a basis for qualifying metallic coatings for use with high strength structural fasteners.

CONTENTS

1. INTRODUCTION	5
2. THEORETICAL BACKGROUND	6
2.1 HYDROGEN EMBRITTLEMENT – BRIEF REVIEW	6
2.2 COATING PROCESSES	7
2.2.1 DACROMET® Coating System	7
2.2.2 Hot-Dip Galvanizing	8
2.2.3 Mechanical Galvanizing	8
3. EXPERIMENTAL PROCEDURE	9
3.1 HARDWARE	9
3.1.1 Test Bolts	9
3.1.2 Nuts and Washers	10
3.1.3 Fixtures	10
3.2 EXPERIMENTAL SETUP	10
3.3 TEST METHODS FOR IFI-144 QUALIFICATION	11
3.4 APPLICATION OF COATINGS	12
3.4.1 DACROMET®	12
3.4.2 Hot-Dip Galvanizing	13
3.4.3 Mechanical Galvanizing	14
3.5 SAMPLING PLAN	15
4. RESULTS AND DISUSSION	17
4.1 HARDNESS	17
4.2 CHEMICAL ANALYSIS	18
4.3 MICROSTRUCTURE	19
4.4 COATING THICKNESS	20
4.5 PAINTABILITY	21
4.6 ADHESION TEST	23
4.7 ROTATIONAL CAPACITY	24
4.8 SALT SPRAY EXPOSURE	25
4.9 CYCLIC EXPOSURE	27
4.10 TENSILE STRENGTH	31

4.11	HYDROGEN EMBRITTLEMENT – PRODUCT TESTING	32
4.12	FRACTOGRAPHY	35
4.13	HYDROGEN EMBRITTLEMENT – PROCESS QUALIFICATION	36
5.	SYNOPSIS	40
5.1	COATING CHARACTERISTICS	40
5.2	CORROSION PERFORMANCE.....	41
5.3	HYDROGEN EMBRITTLEMENT.....	41
6.	CONCLUSIONS.....	44
	ACKNOWLEDGEMENTS	45
	REFERENCES.....	46
	REFERENCED STANDARDS	47
	APPENDICES.....	48
	APPENDIX A: HOT DIP GALVANIZING	49
	APPENDIX B: MECHANICAL GALVANIZING	51
	APPENDIX C: HARDNESS - BOLTS.....	52
	APPENDIX D: HARDNESS - NOTCHED SQUARE BARS	54
	APPENDIX E: COATING THICKNESS - BOLTS	55
	APPENDIX F: COATING THICKNESS - NOTCHED SQUARE BARS.....	58
	APPENDIX G: PAINTABILITY	61
	APPENDIX H: ADHESION	62
	APPENDIX I: ROTATIONAL CAPACITY	63
	APPENDIX J: CONTINUOUS SALT SPRAY	64
	APPENDIX K: CYCLIC TESTING	65
	APPENDIX L: TENSILE STRENGTH.....	68
	APPENDIX M: HYDROGEN EMBRITTLEMENT TESTING.....	69
	APPENDIX N: PROCESS QUALIFICATION.....	70

1. INTRODUCTION

In May of 2000, the Industrial Fasteners Institute (IFI) issued a standard guide named IFI-144, "Test Evaluation Procedures for Coating Qualification Intended for Use on High-Strength Structural Bolts." IFI-144 was designed to serve as a comprehensive testing and validation methodology to qualify metallic coatings for use on high strength structural fasteners, namely ASTM A490 bolts which are characterized by a tensile strength ranging from 150,000 psi to 173,000 psi. The ASTM A490 standard currently prohibits the application of metallic coatings. This prohibition was primarily intended for hot dip zinc, but also includes mechanical deposition, or electroplating of zinc or any other metallic coating. ASTM A490 cites Townsend (Ref. 1), who in 1975 published a study on the risks posed by zinc coatings on stress corrosion cracking and hydrogen embrittlement of low alloy steel.

With the advent of new coating processes and processing technologies, the broadness of the prohibition is being questioned. Common arguments in favor of revisiting the topic are that galvanizing of class 10.9 structural bolts is a standard practice in Europe, and that there is a need in the market for coated A490 bolts. The testing requirements set forth by IFI-144 are designed to first assess if a coating or coating process increases the risk of hydrogen embrittlement failure, while also ensuring the coating's capability to satisfy a comprehensive set of performance criteria such as corrosion resistance, rotational capacity, coating adhesion, and paintability.

The main objective of this investigation was to apply the methodology prescribed in IFI-144 to perform an evaluation of DACROMET® on ASTM A490 bolting, with some comparisons to hot dip galvanizing and mechanical galvanizing.

2. THEORETICAL BACKGROUND

2.1 HYDROGEN EMBRITTLEMENT – BRIEF REVIEW

High strength threaded steel fasteners are broadly characterized by tensile strengths of 150,000 psi and greater. High tensile bolts are often used in critical applications such as bridges, vehicle engines, aircraft and ships. The prevention of hydrogen embrittlement (HE) in these components is a fundamental design and applications consideration. Hydrogen embrittlement is divided into two broad categories based on the source of hydrogen.

Internal Hydrogen Embrittlement (IHE) – also termed *slow strain rate embrittlement* and *delayed failure*; it is caused by residual hydrogen from processing steps such as melting and pickling or from coating processes such as electroplating. This is a particular concern with the coating of high strength steel components, especially fasteners. Consequently a great deal of attention has been paid to IHE phenomena. The delayed nature of this type of hydrogen embrittlement suggests that it is controlled by the trapping mechanism and the diffusion of hydrogen within the matrix. IHE is usually reversible, meaning that ductility can be restored provided microcracks have not been initiated and the traps are not characterized by a high bonding energy.

Environmental Hydrogen Embrittlement (EHE) – is caused by hydrogen introduced into steel from external sources. **Stress Corrosion Cracking (SCC)** is a subset of EHE, and is characterized by corrosion-produced hydrogen being absorbed into steel under applied stress. Other external sources of hydrogen, such as high pressure hydrogen gas or hydrogen sulphide gas can also cause EHE. Most forms of EHE are not reversible because they occur in the presence of stress, resulting in the initiation of microcracks.

For fasteners that have a metallic coating for corrosion protection, SCC failures can be significantly accelerated by a phenomenon known as **Cathodic Hydrogen Absorption (CHA)**. As a general guideline, coatings are selected such that they are anodic with respect to the substrate. A typical example is a zinc coated bolt. If the coating becomes damaged, say on installation or during manipulation, and it is exposed to a corrosive aqueous environment, a galvanic couple is created between the coating and the substrate. The coating is designed to sacrificially corrode to protect the steel bolt from rusting. Normally this intended sacrificial effect is a good thing. However theoretically, the reduction process on the exposed steel surface simultaneously results in the evolution of hydrogen. The quantity of hydrogen being generated increases for coatings with greater corrosion potentials (more sacrificial). In the case of very susceptible and highly stressed materials, this phenomenon will create an in-situ service condition that increases the risk of hydrogen embrittlement failure.

A number of factors affect the behavior of steels exposed to hydrogen and therefore their susceptibility to hydrogen embrittlement. The most significant are hydrogen concentration, applied or residual stress, microstructure and temperature.

Hydrogen Concentration – the first notion to consider is that of a *critical concentration of hydrogen* leading to fracture at a given stress. Below this critical concentration fracture will not occur, regardless of the applied stress.

Threshold Stress – is the second notion to consider. Threshold stress for the onset of hydrogen assisted cracking is defined as the applied stress below which no time dependant cracking will occur regardless of hydrogen concentration, but above which subcritical cracking will lead to time delay fracture. Therefore when considering hydrogen embrittlement, the threshold stress separates finite life from infinite life. At stresses above the threshold, the time to fracture is directly a function of both H concentration and applied stress. The time to fracture decreases as stress increases. Also, the time to fracture decreases as hydrogen concentration increases. In fracture mechanics terminology, the *threshold stress intensity factor* is designated K_{Isc} or K_{IHE} ; a value that decreases with increasing susceptibility.

Microstructure – metallurgical structure has a significant effect on the resistance of steels to HE. Microstructure is broadly determined by composition and heat treatment. When compared at equivalent strength levels, a quenched and tempered fine grain microstructure is more resistant to cracking than bainitic steel. Generally speaking the stress intensity for crack growth also decreases with increasing strength, which is ultimately a function of the microstructure. The influence of microstructure is in fact very complex and not yet fully understood.

Temperature – hydrogen embrittlement in steel is most severe near room temperature, but is significantly less severe at lower or higher temperatures. Lower temperatures reduce the diffusivity of hydrogen and higher temperatures increase the mobility of hydrogen, thus diminishing trapping and favoring outward diffusion.

2.2 COATING PROCESSES

2.2.1 DACROMET® Coating System

DACROMET® is a proprietary coating system licensed by Metal Coatings International (MCII) in Chardon, OH. It is a water-based inorganic zinc-aluminum dispersion coating comprised of overlapping zinc and aluminum flake in a chromium-oxide binder system. Typically a sodium silicate based sealer is applied over the basecoat for additional corrosion protection and also to control the lubricity of parts, which can be a very important application design feature.

Surface preparation consists of alkaline degreasing followed by mechanical descaling. Acid pickling is not permitted in the DACROMET® process, thus effectively eliminating the risk of internal hydrogen embrittlement.

DACROMET® is usually applied to small and medium sized metal components such as fasteners and stampings which can be coated in bulk by the dip-spin process. "Dip-spin" refers to an application process whereby product is placed in a mesh basket, submerged in coating solution, and then spun centrifugally to remove excess coating material. Larger parts such as tubes, large bolts and rods are racked, then either sprayed or immersed. If immersion is used, excess coating material is removed by draining and/or centrifuging. Each application step in the DACROMET® emulsion is followed by a 15 minute curing cycle of the basecoat at roughly 321°C (610°F) part metal temperature. Once the sealer is applied, also by spray or immersion, the parts undergo a 15 minute curing cycle at roughly 177°C (350°F) part metal temperature.

Typical coating thickness can range from 6 to 12 microns. Coating thickness may be varied through successive applications of the basecoat and by controlling the viscosity of the DACROMET® emulsion. The coating coverage by this process is very smooth and uniform.

This coating system was originally developed in the 1970's for the automotive market in an effort to extend product life and reduce warranty costs through improved corrosion protection. DACROMET® and PLUS® sealers typically withstand in excess of 1000 hours salt spray exposure per ASTM B117.

DACROMET® coating standards are specified in ASTM F1136 and F1136M.

2.2.2 Hot-Dip Galvanizing

Hot-dip galvanizing is the process of applying a zinc coating to fabricated iron or steel material by immersing the material in a molten zinc bath. The galvanizing process consists of surface preparation followed by zinc immersion. Hot dip galvanizing standards for fasteners are specified in ASTM F2329. A detailed description of this process is given in 3.4.2 and Appendix A.

2.2.3 Mechanical Galvanizing

Mechanical plating and mechanical galvanizing applies a zinc coating by impaction of particulate zinc in a liquid medium filled with glass beads. The process is preceded by surface preparation. Mechanical galvanizing coating standards are specified in ASTM B695. A detailed description of this process is given in 3.4.3 and Appendix B.

3. EXPERIMENTAL PROCEDURE

3.1 HARDWARE

All test bolts, nuts and washers used for this investigation were taken from homogeneous lots traceable to their respective mill heats of steel. Certified test reports indicating conformance of chemical, mechanical and dimensional properties to the applicable standards are provided in Appendix C.

3.1.1 Test Bolts

The test bolts consisted of two separate lots of one inch diameter ASTM A490 structural bolts supplied by two different manufacturers as shown in Table 1. The first lot, manufactured by St. Louis Screw & Bolt Company (SL) in St. Louis, MO, was made from 4140 steel. The second lot, supplied by Lake Erie Products (LE) in Frankfort, IN, was made from modified 50B40 steel¹. The SL lot was processed normally and was given the designation SL_{std}. The LE lot was quenched and tempered to a target range 39-40 HRC hardness, which represents the upper range of the allowable hardness in ASTM A490, to maximize susceptibility to HE failure. This lot was given the designation LE_{spe}.

Table 1: Test Bolts

Manufacturer	Size (inch)	Material Grade	Target Mid-Radius Hardness (HRC)	Description	Designation
St. Louis Screw & Bolt Company St. Louis, MO	1-8 x 5	4140	33-36	Standard ASTM A490 bolts	SL_{std}
Lake Erie Products Frankfort, IN	1-8 x 5	50B40	38-40	LE "Special" ASTM A490 bolts – manufactured expressly for this study at the upper limit of A490 allowable hardness	LE_{spe}

¹ The material certificate for this lot was not available. Chemistry and steel grade were determined by spectrochemical analysis. See Section 4.2 for results.

3.1.2 Nuts and Washers

In addition to bolts, heavy hex DH nuts per ASTM A563, and hardened washers per ASTM F436 were procured. The test parts were grouped as sets consisting of bolts, nuts and washers with the same coating.

3.1.3 Fixtures

The fixtures used for mounting the test parts were manufactured in accordance with Section 7.0 in IFI-144. The material used was 4140 steel machined into rectangular blocks with a drilled hole along the longitudinal axis for inserting the bolts. Fixture dimensions and configuration are illustrated in Figure 3. Hardness was 96 to 100 Rockwell B. The fixtures were coated with DACROMET® in order to provide corrosion protection and to minimize the difference of corrosion potential with coated test parts.

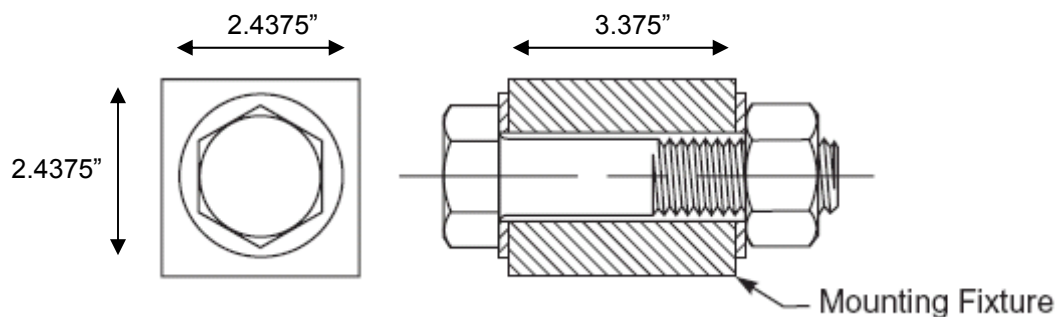

Figure 1: Test Parts and Fixture

3.2 EXPERIMENTAL SETUP

This test program was started in 2001 using the standard ASTM A490 bolts manufactured by St. Louis Screw & Bolt (SL_{std}). It was subsequently decided in 2003 to introduce test bolts that would be representative of the worst case scenario in terms of susceptibility to HE. Consequently, Lake Erie Products manufactured “special” high hardness A490 bolts specifically for this study (LE_{spe}). These parts were used for the cyclic testing per GM9540P, and subsequent hydrogen embrittlement testing. The two lots of test bolts will be addressed separately.

The SL_{std} test bolts were divided into four separate batches, three of which were coated by the three coating processes. One batch was left uncoated. Coatings were

applied by industrial facilities under normal operating conditions. The bolts underwent initial testing of coating characteristics such as thickness, paintability, adhesion and rotational capacity (in matching sets). They were then exposed to salt spray for 5000 hours per ASTM B117, after which standard tensile testing per ASTM F606 was performed on selected parts.

Additionally, each coating process was sampled for the risk of internal hydrogen embrittlement (IHE) by including “witness” notched square bar specimens with each batch of SL_{std} bolts being coated, in accordance with ASTM F1940.

The LE_{spe} test bolts were divided into two batches, one of which was coated by the DACROMET® process, applied by an industrial facility under normal operating conditions. The second batch was left uncoated. The parts were then mounted into the test fixtures along with DACROMET® coated nuts and washers for cyclic exposure per GM 9540P. Cyclic exposure was performed under two conditions. The first condition comprised parts that were tightened in accordance with the turn-of-nut method prescribed by the Research Council on Structural Connections (Ref. 2). This was designed to simulate most severe service conditions. The second condition comprised parts that were merely finger tightened into the fixtures. This second condition would serve as a baseline for estimating the influence of applied stress on the integrity of the fasteners. Following exposure for 120 cycles, the parts were disassembled from the fixtures and underwent hydrogen embrittlement testing.

Additionally, parts from both lots of bolts (SL_{std} & LE_{spe}) were tested for hardness, chemistry, and microstructure. Fractographic analysis was also performed on parts following hydrogen embrittlement testing.

3.3 TEST METHODS FOR IFI-144 QUALIFICATION

The following is a listing of test methods required by IFI-144. A detailed description of each test method will be included in Section 4, Results.

- Coating Thickness – per ASTM D1186
- Paintability – visual & per ASTM D3359
- Coating Adhesion – per ASTM B571
- Rotational Capacity – per ASTM A325
- Salt Spray Exposure – per ASTM B117
- Tensile Strength – per ASTM F606
- Hardness – per ASTM F606
- Cyclic Exposure – per GM9540P
 - Under Load
 - No Load
- Hydrogen Embrittlement
 - Product – per ASTM F1624
 - Process – per ASTM 1940

3.4 APPLICATION OF COATINGS

3.4.1 DACROMET®

DACROMET® P (DACROMET® basecoat + PLUS® Sealer) and DACROMET® XL (DACROMET® basecoat + PLUS® XL Sealer) Coating Systems were applied by Michigan Metal Coatings in Rochester Hills, MI, an applicator licensed to apply DACROMET®, in February, 2004. The dip-spin application method was used with a target coating thickness of 8 microns. The applied processing steps were as follows.

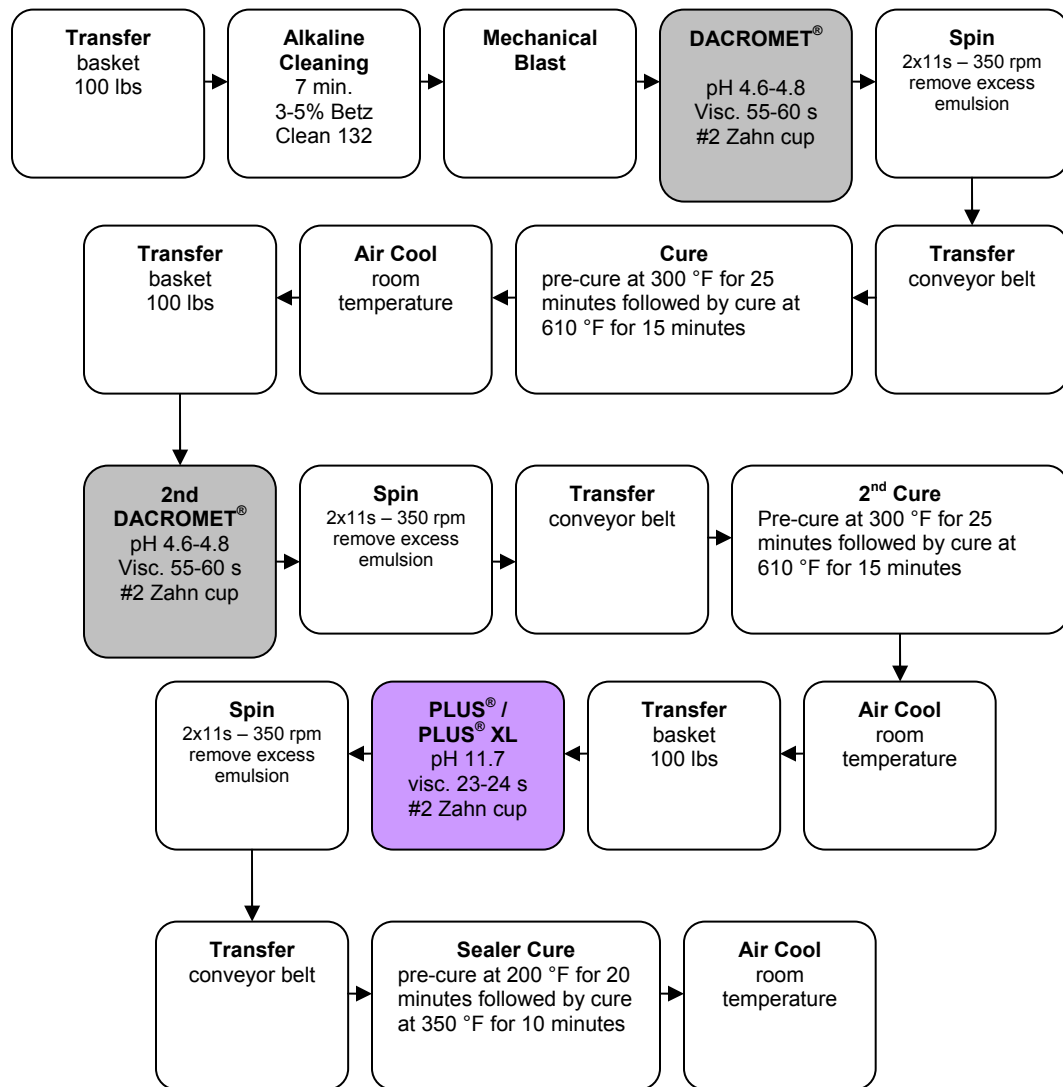

Figure 2: DACROMET® Processing Steps. Note - DACROMET® applied by dip-spin requires two coats of basecoat

3.4.2 Hot-Dip Galvanizing

The hot dip zinc coating was applied by Galvano in Beloeil, Quebec in February, 2004. The target coating thickness was approximately 60 microns. The applied processing steps were as follows.

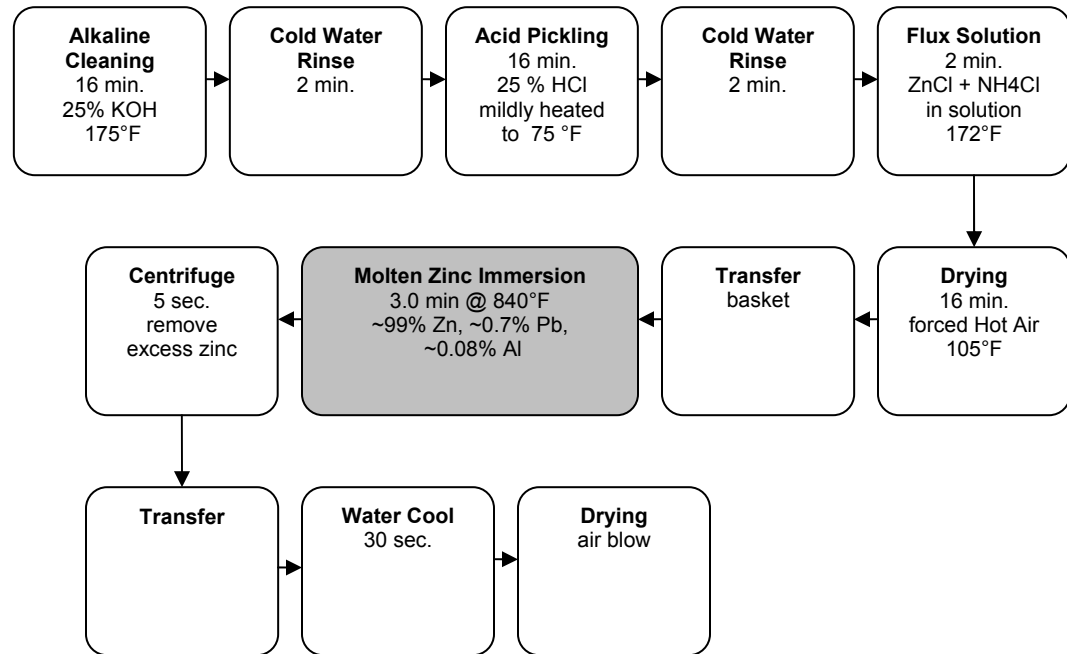

Figure 3: Hot Dip Galvanizing Processing Steps

Process sampling in accordance with ASTM F1940 was conducted under four process conditions as described below.

Table 2: ASTM F1940 Process Sampling Conditions

HDG Batch 1: no exposure to acid
Bolts were sand blasted + 2 min flux
Specimens were acetone cleaned + 2 min flux
HDG Batch 2: zinc dip only (specimens)
SQB specimens were acetone cleaned
HDG Batch 3: normal process
Bolts left as is
SQB specimens were left as is
TMP Batch 4: heat exposure in furnace
SQB specimens were acetone cleaned
Furnace at part temperature of 845°F for 7 minutes

3.4.3 Mechanical Galvanizing

The mechanical galvanized coating was applied by New Toro Plating & Polishing Company Ltd., Concord, Ontario in February, 2004. The target coating thickness was approximately 60 microns. The processing steps were as follows.

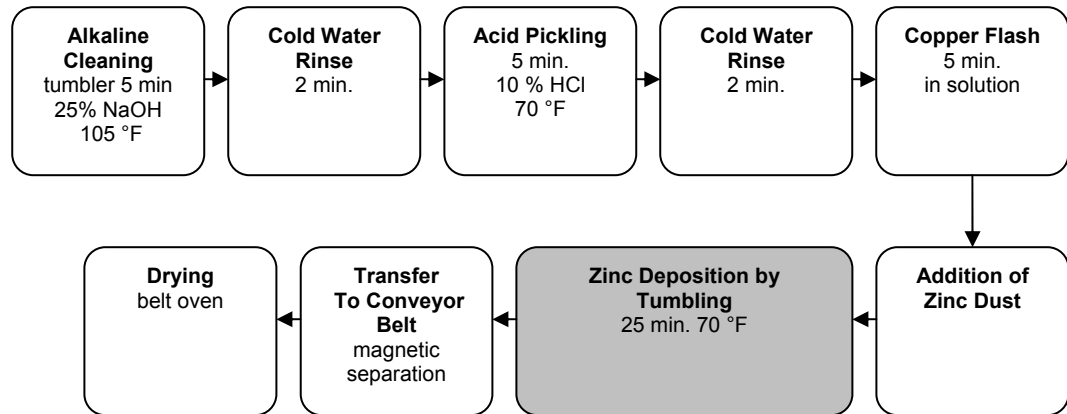

Figure 4: Mechanical Galvanizing Processing Steps

3.5 SAMPLING PLAN

Sampling plans for tests performed on the two lots of ASTM A490 bolts is shown in Tables 3 and 4. Table 5 details the sampling plan applied to the three coating processes for qualification per ASTM F1940. The sampling plans were designed to satisfy the requirements of IFI-144, but also include additional testing not explicitly specified.

Table 3: Sampling Plan – Standard A490 Lot (SL_{std})

Test Performed	Specification	Coating	Sample Size
Hardness	ASTM F606	N/A	3 HRC 3HV
Chemical Analysis	ASTM A751	N/A	3
Microstructure	ASTM E3	N/A	3
Coating Thickness	ASTM D1186	DACROMET® P	5
		HDG	5
		MG	5
Paintability	Visual and ASTM D3359	DACROMET® P	5
Adhesion	ASTM B571	DACROMET® P	5
Rotational Capacity	ASTM A325	DACROMET® P	10
5000 Hour Salt Spray Exposure	ASTM B117 and ASTM D1654	DACROMET® P	10
		MG	10
		HDG	10
Tensile Pull	ASTM F606	Bare (Pre Exposure)	3
		DACROMET®P (Post Exposure)	5

Table 4: Sampling Plan – High Hardness A490 Lot (LE_{spe})

Test Performed	Specification	Coating	Tightening Condition	Exposure	Sample Size
Hardness	ASTM F606	N/A	N/A	N/A	3 HRC 3HV
Chemical Analysis	ASTM A751	N/A	N/A	N/A	3
Microstructure	ASTM E3	N/A	N/A	N/A	3
Cyclic Exposure	GM9540P	Bare	Finger tightened	120 Cycles	1
		DACROMET® P	Finger tightened	120 Cycles	5
		Bare	Turn-of-nut ½ turn	120 Cycles	1
		DACROMET® P	Turn-of-nut ½ turn	120 Cycles	5
Tensile Pull (Fast Fracture Baseline)	ASTM F606	Bare	None	None	3
Hydrogen Embrittlement	ASTM F1624	Bare	Finger tightened	120 Cycles	1
		DACROMET® P	Finger tightened	120 Cycles	5
		Bare	Turn-of-nut ½ turn	120 Cycles	1
		DACROMET® P	Turn-of-nut ½ turn	120 Cycles	5

Table 5: Sampling Plan – Coating Processes per ASTM F1940

Coating Process	Condition	Description	SQB Sample Size
None	Blank	Bare uncoated specimens	5
DACROMET®	DAC	DACROMET®	2x 3
Hot Dip Galvanizing	HDG Batch 1	No acid pickling	1x 3
	HDG Batch 2	Direct immersion in kettle	1x 3
	HDG Batch 3	Regular galvanizing process	1x 3
	TMP Batch 4	Heat exposure only	1x 3
Mechanical Galvanizing	MG	Mechanical Galvanizing	2x 3

4. RESULTS AND DISCUSSION

This section contains summary results. Complete results and supplementary images for each test method can be found in the Appendix section.

4.1 HARDNESS

Hardness was measured using two different methods, Rockwell C and Vickers macro-hardness. The latter is better suited for analytical purposes and was used to obtain a more accurate hardness profile.

Hardness testing was performed on both lots of bolts. Rockwell C Hardness was measured in accordance with ASTM F606 at four mid-radius points of a cross section, one diameter from the end of each bolt, with a test force of 150 Kg. Vickers macro-hardness was measured at 15 locations: 5 along the edge, 5 at mid-radius and 5 at centre of the same cross section, with a test force of 5 Kg, and indentation dwell time of 10 seconds.

The SL_{std} bolts measured an average of 34.4 HRC and between 353 and 367 HV from center to edge. The LE_{spe} bolts measured an average of 37.5 HRC and between 404 and 417 HV from center to edge. Vickers test results are typically slightly higher, when converted to Rockwell C scale, than those obtained with a Rockwell machine. This effect can be seen here as the Vickers results were 1.6 to 2.5 HRC points higher. Based on the more precise Vickers results, the LE_{spe} bolts are at, or slightly exceed the 39 HRC limit allowed by ASTM A490, and that consistent through-hardening was achieved in both cases.

Table 6: Summary Bolt Hardness Results

Vickers Macro Hardness - 5 Kgf						
3 samples - 15 indentations per sample (5 per area)						
	SL_{std}			LE_{spe}		
	Center	Mid Radius	Outer	Center	Mid Radius	Outer
Lot Avg.	353.3	362.9	367.4	404.0	411.2	417.3
Avg. Std. Dev.	5.9	12.0	10.8	5.0	4.3	9.9
Avg % Std. Dev.	1.67%	3.32%	2.94%	1.23%	1.03%	2.39%
Converted to HRC	35.0	36.0	36.5	39.5	40.0	40.4
Rockwell C - Mid Radius - 150 Kgf						
3 samples - 4 indentations per sample						
Lot Avg.	34.4			37.5		
Avg. Std. Dev.	1.025			0.852		
Avg % Std. Dev.	2.98%			2.27%		

Note: ASTM A490 specified hardness range: 33-39HRC

4.2 CHEMICAL ANALYSIS

An optical emission spectrometer (OES) was used to perform chemical analyses of sample bolts. The results confirmed that the SL_{std} bolts were made of 4140 chromium-molybdenum alloy steel, as was certified by the manufacturer. No material certificate was available for the LE_{spe} bolts; however the chemical analysis confirmed that they were made of chromium-molybdenum alloy boron steel. The chemistry most closely matches that of 50B40 steel with the exception of an apparent addition of molybdenum.

Table 7: Average Chemical Analysis Results

Element	% Conc.	
	SL _{std}	LE _{spe}
Carbon	0.42	0.41
Manganese	0.83	0.97
Phosphorus	0.014	0.012
Sulfur	0.015	0.004
Silicon	0.28	0.26
Copper	0.071	0.029
Nickel	0.07	0.021
Chromium	0.96	0.34
Molybdenum	0.16	0.23
Vanadium	0.008	0.008
Niobium	0.006	0.008
Cobalt	0.014	0.012
Tin	0.008	0.005
Titanium	0.001	0.002
Aluminum	0.022	0.039
Boron	—	0.0023
Steel Grade	4140	50B40 (+ Mo)

4.3 MICROSTRUCTURE

Sample bolts were cross sectioned using a diamond saw and mounted in bakelite resin. The samples were polished respectively with 120, 240, 320, 400 and 600 grit sandpaper. The mounts were then polished respectively with 9 μ m, 3 μ m and 1 μ m diamond suspension. Finally the samples were etched using 3% Nital solution. Microstructure was examined using a CLEMEX optical metallograph and recorded as digital photomicrographs. Microstructure images in Figures 5 and 6 illustrate that both bolt lots had very similar fine tempered martensitic structure.

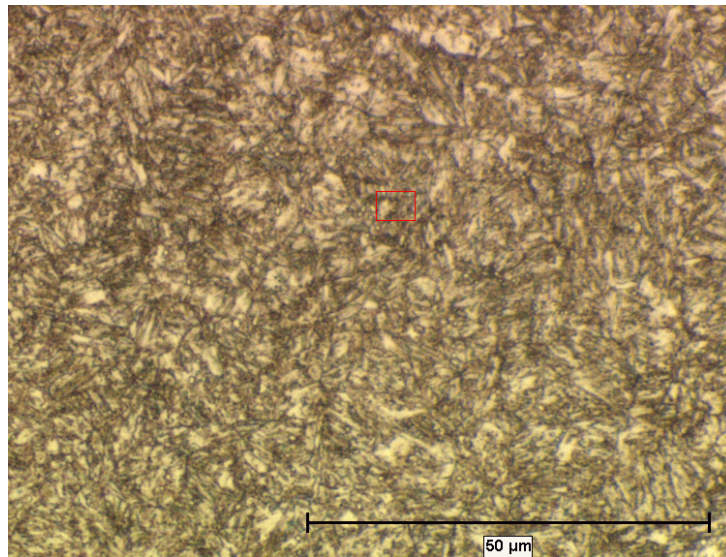

Figure 5: Microstructure SL_{std} Center - 1000X

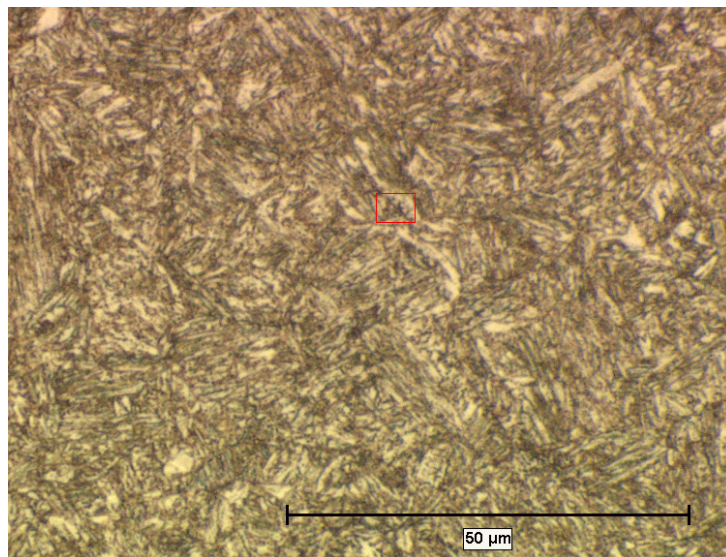

Figure 6: Microstructure LE_{spe} Center - 1000X

4.4 COATING THICKNESS

The coating thickness on all parts was measured in accordance with ASTM D1186 using Fisherscope MMS magnetic induction testers. The results, given in Table 8 and illustrated in Figure 7, showed that the DACROMET® coating thickness of 9 µm was approximately one order of magnitude less than that of the other two coatings. In addition, it was observed that the hot dip zinc coating is slightly thicker than the mechanically deposited zinc. This observation is limited to these particular lots, as the reverse can also be true.

Table 8: Average Coating Thickness Data (English and Metric)

	Thickness (mil)					
	Bolts			SQB's		
	Avg	Std Dev	% Std D	Avg	Std Dev	% Std D
DACROMET®	0.37	0.15	41.4%	0.33	0.048	14.5%
Hot Dip	3.63	0.51	13.9%	3.15	0.46	13.8%
Mechanical	2.60	0.18	6.9%	2.38	0.10	4.1%

	Thickness (µm)					
	Bolts			SQB's		
	Avg	Std Dev	% Std D	Avg	Std Dev	% Std D
DACROMET®	9.28	3.84	41.4%	8.4	1.22	14.5%
Hot Dip	92.32	12.85	13.9%	80.0	11.76	13.8%
Mechanical	66.15	4.55	6.9%	60.4	2.48	4.1%

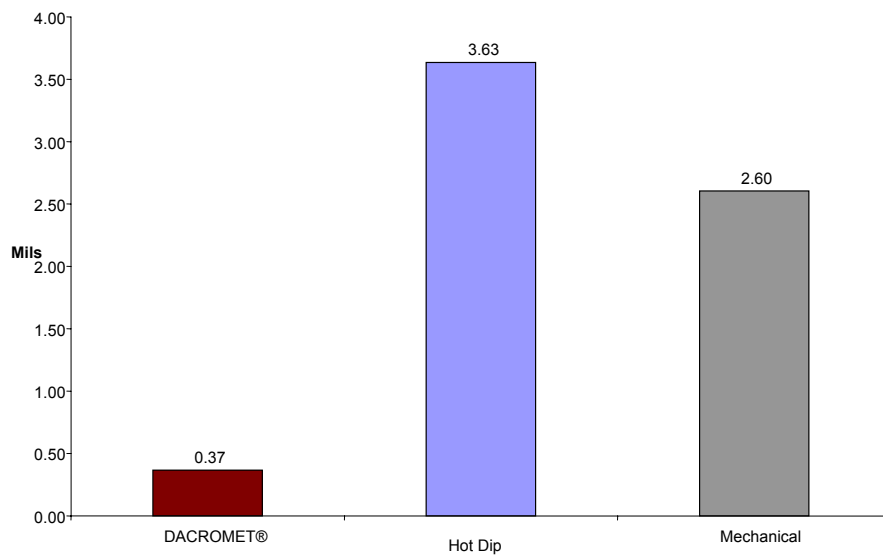

Figure 7: Average Coating Thickness

4.5 PAINTABILITY

IFI-144 stipulates that *“Paint shall be applied to the fastener which is coated with the proposed material coating seeking qualification. Paint may be applied by spraying or brushing. After 48 hours, the painted fastener shall be dry to the touch.”*

The paint system used for this test was Carbozinc 11 Primer and Carboxane 2000, which are commonly used in structural applications such as bridges (Fig. 8). Paint was applied to the DACROMET® P coated bolts (head, threads, shank) by brushing, and was allowed to cure for 48 hours, after which it was verified to be dry to the touch. This satisfied the requirement in IFI-144. Carbozinc 11 Primer thickness was 60 microns (2.4 mils). Carboxane 2000 Topcoat thickness was 90 microns (3.5 mils). Thickness was measured using a Fischerscope MMS instrument.

An additional adhesion test per ASTM D3359 Procedure A was conducted on the painted bolts. An X-scribe was made on the head, cutting the paint to expose the substrate (Fig. 9). Permacel 99 tape was then applied over the cut and removed at an angle as close to 180°. The specified minimum bond strength of Permacel 99 is 45 g/mm. The test was performed on parts, both before and after salt spray exposure. The adhesion of the paint was rated in accordance with the scale in Table 9. The scores obtained were 4A and 3A, which are acceptable by industry standards.



**Figure 8: Successive paint steps
left to right: unpainted, Carbozinc 11 Primer, and Carboxane 2000**



Figure 9: X-scribe

Table 9: ASTM D3359 Rating Scale

A	No peeling or removal
4A	Trace peeling or removal along incisions or at their intersection
3A	Jagged removal along incisions up to 1.6 mm on either side
2A	Jagged removal along most of incisions up to 3.2 mm on either side
1A	Removal from most of the area of the X under the tape
0A	Removal beyond the area of the X

4.6 ADHESION TEST

IFI-144 stipulates adhesion testing in accordance with ASTM B571.

The scribe-grid test (Test 13) was performed on the DACROMET® P coated bolts. The coating on each sample was scribed in three parallel lines with sufficient pressure to penetrate the coating and expose the substrate (Fig. 10). This was followed by the application of Permacel 99 tape to the area with firm finger pressure. The specified minimum bond strength of Permacel 99 is 45 g/mm. The tape was then removed rapidly at an angle as close to 180° as possible. No portion of the coating between the parallel lines broke away from the substrate, indicating satisfactory adhesion.



Figure 10: Scribe Grid Test

4.7 ROTATIONAL CAPACITY

IFI-144 stipulates that “*rotational capacity testing be conducted in accordance with ASTM A325.*” This test is designed to verify that the assembly (bolt/nut/washer) is sufficiently lubricated to allow for proper installation in the field.

Rotational capacity testing was performed using a Skidmore-Wilhelm instrument. This device measures the load in an assembly by means of a load cell situated between the mating parts. Bolts and washers were coated with DACROMET® P and nuts were coated with DACROMET® XL. Each assembly was initially tightened to 180 degrees from snug to achieve the minimum specified preload. The nut was then further rotated past one full turn (363 degrees), at which point additional torque and load readings were taken. None of the tested assemblies experienced shear failure of the nut threads, or torsional/tensional failure of the bolt. Upon removal of each nut from bolt, the components were visually inspected for any signs of failure; none was observed.

The average torque/tension results obtained at 180 degrees and the final load at 363 degrees are shown in Table 10. The average friction factor K was approximately 0.1, which attests to the high lubricity of the PLUS® and PLUS® XL sealers applied over the DACROMET® finish. This point is further illustrated by the high tension, roughly 96,000 lbf, achieved at 363 degrees without torsional/tensional failure of the bolt.

Table 10: Summary Rotational Capacity Test Results

	Tension at 180°	Torque at 180°	Coefficient of Friction	Final Tension at 363°
	(lbf)	(ft-lbs)	K=T/(DF)	(lbf)
Avg	64,832	548	0.102	96,187
Std Dev	243.1	13.5	0.00251	2108
% Std D	0.38%	2.46%	2.48%	2.19%

Note 1: specified minimum bolt pre-tension: 64,000 lbf at nut rotation of 180° (per Table 8.1 in RCSC Specification)

Note 2: final rotational capacity nut rotation: 360° (per ASTM A325)

4.8 SALT SPRAY EXPOSURE

IFI-144 requires that salt spray testing (SST) in accordance with ASTM B117 be conducted for a continuous exposure period of 1000 hours. Parts are to be evaluated for the percentage of red rust on significant surfaces per ASTM D165.

All three coatings types were tested in order to compare their corrosion performance. After 1000 hours of exposure, the parts were rinsed with warm water and evaluated. No red rust was observed on DACROMET® P coated parts. In comparison, in excess of 85% red rust was observed on significant surfaces of mechanical galvanized parts (bolts especially). Between 10 and 25% red rust was observed on significant surfaces of hot dip zinc coated parts.

The test was then extended by an additional 4000 continuous hours for a total of 5000 hours of salt spray exposure. Very little red rust was observed on DACROMET® P coated parts. In comparison the significant surfaces of mechanical galvanized and hot dip zinc coated parts were almost completely covered in red rust. The results are summarized in Table 11 and illustrated in Figures 11 to 14.

Table 11: Summary Salt Spray Exposure Results

Avg	DACROMET® P			Mechanical Galvanized			Hot Dip Galvanized		
	Bolt	Nut	Washer	Bolt	Nut	Washer	Bolt	Nut	Washer
1000 hrs	0	0	0	84.5	21	25.5	8.5	10	24.5
5000 hrs	5.9	0.05	28.42	100	99	100	71	100	100

Note: values represent percentage of red rust. All HDG bolts exhibited 75-90% red rust with 50% of the red rust obscured by white corrosion product.



Figure 11: SL_{std} (Bare Unexposed)



Figure 12: SL_{std} (DACROMET® + 5000 hrs per ASTM B117)



Figure 13: SL_{std} (HDG + 5000 hrs per ASTM B117)



Figure 14: SL_{std} (MG + 5000 hrs per ASTM B117)

4.9 CYCLIC EXPOSURE

Extensive research conducted by the automotive industry has shown that accelerated cyclic testing, unlike continuous salt spray testing, provides a more useful correlation to real-world exposure of automobiles. Although the eventual service life of a vehicle will always depend on the specific conditions to which it is exposed, cycles of salt spray, humidity, heat, and drying are more representative of service conditions than is a continuous salt spray. Accelerated cyclic exposure tests are used to qualify individual components and complete vehicles to satisfy a ten-year life requirement. The most commonly used cyclic test across a number of industries is GM 9540P. This test method prescribes 24 hour cycles of salt spray, humidity and elevated temperature drying. The corrosiveness of the test environment is calibrated by simultaneously exposing corrosion coupons, made of AISI 1006 to 1010 bare steel, and measuring their mass loss at the end of the test period.

IFI-144 requires that cyclic testing in accordance with GM 9540P be performed for an exposure period of 80 cycles on bolt/nut/washer assemblies mounted into fixtures in the loaded and unloaded conditions.

Only DACROMET® P coated high hardness LE_{spe} bolts were used for this test. As was mentioned earlier the LE_{spe} bolts, by virtue of their higher hardness, were expected to represent the most susceptible A490 bolt material condition for hydrogen embrittlement failure. Two separate sets of assemblies were tested. The first was under load, which by applying stress to high hardness parts in a highly corrosive environment, simulates “worst case” service conditions for stress corrosion cracking (SCC). In this condition, the bolts/nuts/washers were assembled in fixtures by the turn-of-nut method. The assemblies in the second set of were not loaded. In this condition, the bolts/nuts/washers were finger tightened into the fixtures.

The total exposure time was 120 cycles, which exceeds the 80 cycle requirement in IFI-144. Following exposure to 40, 80, and 120 cycles respectively, the parts were rinsed with warm water and evaluated for percentage of red rust on significant surfaces per ASTM D1654. Even after 120 cycles of exposure, very little or no red rust was observed on significant surfaces of the test parts. This result, reinforced by the SST results, demonstrated the superior corrosion protection offered by the DACROMET® P finish. The results are given in Table 12.

In order to evaluate the corrosion weight loss of exposed parts, each component and the entire assembly were weighed prior to and following exposure. An uncoated control bolt (BARE) was used for baseline comparison with the DACROMET® P coated hardware. As is shown in Table 13, the DACROMET® P coated hardware did not experience any weight loss. In fact, a slight weight gain, probably due to the presence of oxides and residues, was noted. In comparison, the BARE control bolt exhibited measurable weight loss in the order 1%. (Figures 15 to 20)

Table 12: Summary Salt Spray Exposure Results

Load (Turn-of-Nut Tightened)			
Corrosion after n Cycles			
	40	80	120
DACROMET® P	<1%	<1%	3%
	0%	0%	<1%
	0%	<1%	<1%
	<1%	<1%	<1%
	<1%	<1%	<1%
Control (Bare)	95%	100%	100%

No Load (Hand Tightened)			
Corrosion after n Cycles			
	40	80	120
DACROMET® P	<1%	<1%	<1%
	<1%	1%	5%
	0%	0%	0%
	0%	0%	0%
	<1%	<1%	<1%
Control (Bare)	90%	100%	100%

Values indicate % red rust

Table 13: Summary Salt Spray Exposure Results

Load (Turn-of-Nut Tightened)						
	Bolt	Nut	W1	W2	Fixture	Assmby
Avg DACROMET® P Weight Change (g)	0.06	0.01	0.02	0.02	0.22	0.32
Bare Weight Change (g)	(10.41)	(8.73)	(2.86)	(2.32)	1.00	(23.32)

No Load (Hand Tightened)						
	Bolt	Nut	W1	W2	Fixture	Assmby
Avg DACROMET® P Weight Change (g)	0.09	0.05	0.04	0.02	1.00	1.19
Bare Weight Change (g)	(7.18)	(7.49)	0.64	(0.45)	0.70	(13.78)

Corrosion coupons: 80 cycle mass loss: 8,175 mg
 120 Cycle Mass Loss: 10,645 mg



Figure 15: Mounted Assembly



Figure 16: LE_{spe} (Bare Unexposed)



Figure 17:
LE_{spe} (Bare + 120 cycles)



Figure 18:
LE_{spe} (Bare + Turn-of-Nut + 120 cycles)



Figure 19: LE_{spe} (DACROMET® + 120 cycles)



Figure 20: LE_{spe} (DACROMET® + Turn-of-Nut + 120 cycles)

4.10 TENSILE STRENGTH

IFI-144 stipulates that parts be axially tensile tested after continuous salt spray and cyclic exposure. This requirement is meant to verify if any loss of strength has resulted from corrosion degradation. In addition, tensile testing was used to verify the initial (baseline) strength of the two bolt lots. Testing was performed on uncoated LE_{spe} and SL_{std} bolts prior to exposure and on DACROMET® P coated SL_{std} bolts following 5000 hours of salt spray exposure. The tests were conducted using a high capacity Satec tensile testing machine in accordance with ASTM F606.

Summary results are given in Table 14. The breaking load of bare-unexposed SL_{std} bolts was roughly 99,000 lbf. This result is in agreement with the values reported on the manufacturer's certified test report. Parts tested after exposure averaged roughly 101,000 lbf. Therefore no loss of strength resulted from 5000 hours of SST exposure.

The breaking load of bare-unexposed LE_{spe} bolts was roughly 109,000 lbf, which, as expected, exceeds the maximum 104,850 allowed by ASTM A490. This result correlates with the high hardness of the LE_{spe} bolts. In practice it is very difficult to approach the upper hardness limit of 39 HRC without exceeding the upper tensile strength limit of 173,000 psi, especially for larger diameters such as in this case. This value was used as the baseline strength for subsequent HE testing of LE_{spe} bolts after cyclic exposure.

Table 14: Summary Tensile Strength Results

'Fast Fracture' Tensile load (lbf) (Loading Rate: 2810 lb/sec)			
	Average	Std Dev	% Std D
SL _{std} Bare, pre-exposure	99,313	1,176	1.18%
SL _{std} DACROMET® P Post 5000 hr SST	101,142	1,969	1.95%
LE _{spe} Bare, pre-exposure	109,163	748	0.69%

ASTM A490 Specified Tensile Strength (lbf)
90,900 min
104,850 max

4.11 HYDROGEN EMBRITTLEMENT – PRODUCT TESTING

Following 120 cycles of exposure per GM 9540P, hydrogen embrittlement (HE) testing was performed on the BARE bolts and DACROMET® P coated LE_{spe} bolts. The adopted approach was based on the time dependant methodology described in ASTM F1624. The test method was designed to measure any drop in threshold stress as a result of corrosion-generated hydrogen. The slow loading rate was intended to allow for the time dependant nature of hydrogen related degradation (if any) to take effect. Due to the size and strength of the bolts, the testing was conducted using the same high capacity Satec tensile testing machine as was used for standard tensile testing. Slow strain rate (SSR) loading was used instead of incremental step loading (ISL).

The bolts were axially loaded in tension at a continuous but slow strain rate of 5000 lbf/hr. The loading rate was selected such as to allow roughly 24 hours of loading until fracture. All tests were conducted in air.

The baseline strength value used for this test was the fast fracture load (FFS), obtained during tensile testing in Section 4.10. The ratio of the SSR fracture load for each sample over the fast fracture load equals the percent fracture strength (FS%), which is a measure of the threshold stress.

$$FS\% = \frac{FS}{FFS} \times 100 \quad (\text{Eq.1})$$

Where:

FS% = Percent Fracture Strength

FS = SSR Fracture load of coated bolt following 120 cycles of exposure

FFS = Fast Fracture load of coated of Bare unexposed bolt

The finger-tightened and the turn-of-nut-tightened DACROMET® P coated LE_{spe} bolts yielded very similar averaged results, 107,054 lbf and 105,884 lbf respectively. The average percent fracture strength (FS%) results were 98% and 97% respectively. These results indicate that there was no significant change in fracture strength from exposure to 120 accelerated corrosion cycles per GM 9540P. The results are supported by the fact that none or very little amounts of red rust were observed on the coated bolts. The DACROMET® P coating effectively prevented corrosion of the substrate steel, thus limiting corrosion-generated hydrogen. It should be noted that a small amount of red rust was observed at the corner of the

hex on one sample in each batch. Evidently the small breach at the corner of the head did not influence the fracture strength, which would also seem to indicate that cathodic hydrogen absorption did not play a significant role.

In comparison to the results for the DACROMET® coated bolts, the uncoated finger-tightened sample also did not exhibit any loss in fracture strength, whereas the uncoated turn-of-nut-tightened sample had a slightly lower percent fracture strength of 89%, representing a marginal drop of about 8-10%. In the absence of stress, uncoated bolts predictably do not exhibit a change in fracture strength. However, in the presence of high stress (near yield) from turn-of-nut tightening; it is probable that the high hardness LE_{spe} bolts were marginally affected by corrosion-generated hydrogen absorbed into the bolt material. It should be noted that the single data point for these two conditions does not allow for any definitive statement in this regard. Test results are given in Table 15 and illustrated in Figure 21.

Table 15: Summary HE Test Results

	Breaking Load (lbs)			
	Turn-of-nut (1/2 turn)		Finger Tightened	
	Bare	DACROMET® P	Bare	DACROMET® P
Avg	96,810	107,054	107,590	105,884
Std Dev	n/a (single point)	3,713	n/a (single point)	2,267
% Std D		3.47%		2.14%
	Percent Fracture Strength (FS%)			
Avg	89%	98%	99%	97%
Std Dev	n/a (single point)	3.40%	n/a (single point)	2.08%

Bolt Type: LE_{spe}
 Test Environment: Air
 Loading Rate: 5000 lb/hr
 Baseline (FS): 109,163 lbf

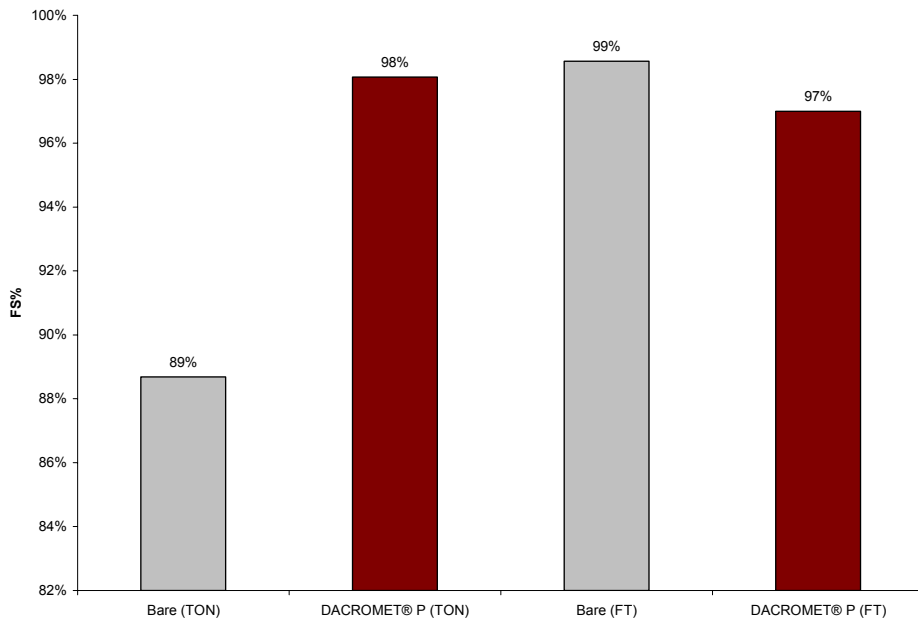

Figure 21: Summary HE Test Results

4.12 FRACTOGRAPHY

A JEOL JSM-840A Scanning Electron Microscope (SEM) equipped with a conventional tungsten hairpin electron gun was used to study the fracture surfaces of the HE tested bolts. Clear topographical images were generated at magnifications up to 2000X at an accelerating voltage of 15KV with secondary electrons (SE) collected by the Everhart-Thornley (E-T) detector. The working distance (WD) was set to 38 mm and the aperture selector set to 3.

Careful examination of the fracture surfaces, including close scrutiny of the perimeters did not reveal any sign of intergranular morphology typical of hydrogen assisted cracking. The predominant fracture surface morphology of all four sample conditions subjected to HE testing was ductile, characterized by dimples as illustrated in Figure 22. These fracture surfaces were no different from the BARE unexposed baseline sample subjected to standard tensile testing.

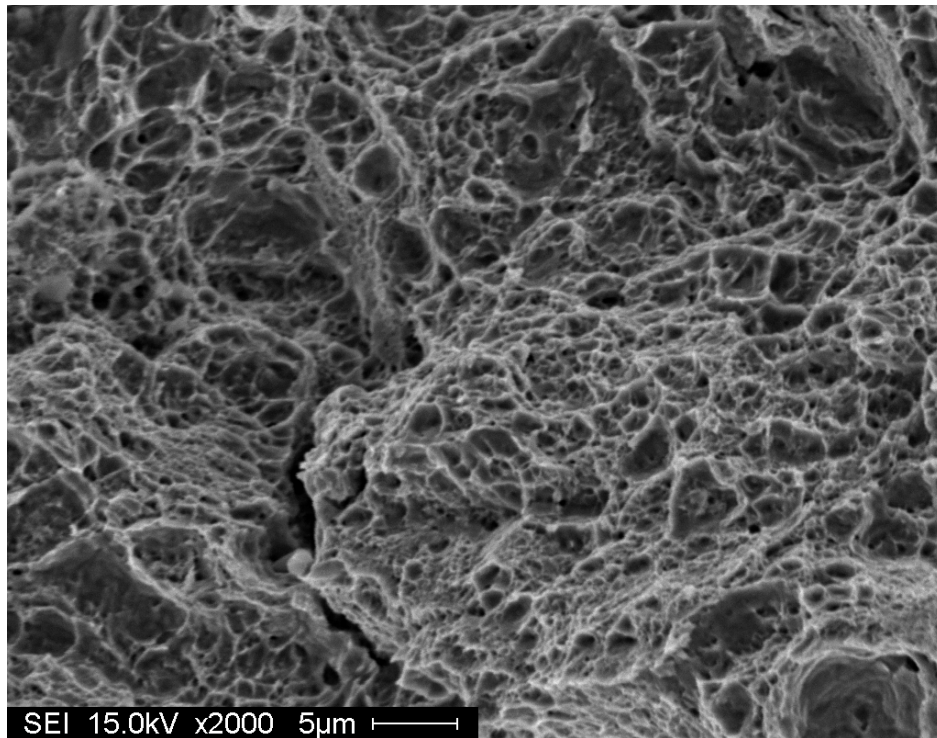

Figure 22: Ductile Fracture Morphology
LE_{spe} (DACROMET® + Turn-of-Nut + 120 cycles)

4.13 HYDROGEN EMBRITTLEMENT – PROCESS QUALIFICATION

The incremental step load test method described in ASTM F1624 was modified and adapted in ASTM F1940 to provide a methodology for quantifying the risk of internal hydrogen embrittlement (IHE) posed by a coating process.

The test consists of using a standardized specimen as a “witness” by processing it with production parts. In doing so, it is exposed to the same conditions as the parts. The test specimen is a standardized notched square bar (SQB) made of highly susceptible AISI E4340 steel heat treated to 50-52 Rockwell C hardness. In terms of HE susceptibility, this specimen represents the worst case scenario because production fasteners will never be more susceptible than the SQB specimens. Fastener product specifications for class 12.9 fasteners set a maximum allowable hardness limit of 44 Rockwell C.

ASTM F1940 also specifies a standardized test protocol with pre-defined load/strain increments and hold times. The SQB specimen is subjected to a sustained four-point bending load and slow strain rate under displacement control. The test indirectly quantifies the amount of residual hydrogen in the SQB specimen by measuring the threshold for hydrogen stress cracking in an accelerated manner (<=24 h).

Once again the threshold, also known as the Notch Fracture Strength (NFS) is defined as the maximum load at the onset of cracking that is identified by a 5 % drop in load under displacement control. Bare (uncoated) SQB specimens are tested in the same manner to establish a baseline Notch Fracture Strength. The ratio of the threshold for each witness test specimen over the baseline represents the percent Notch Fracture Strength (%NFS).

$$NFS\% = \frac{NFS_{(W)F1940}}{NFS_{(B)F1940}} \times 100 \quad (\text{Eq.2})$$

Where:

NFS% = Percent Notch Fracture Strength
 NFS_{(W)F1940} = Notch fracture load of coated SQB witness specimen
 NFS_{(B)F1940} = Notch fracture load of bare SQB specimen

The NFS% ratio represents the quantified risk of IHE from a coating process. ASTM F1940 establishes an acceptability limit which is equivalent to 85%². In other words

² ASTM F1940 proposes an acceptability limit of 75% when NFS% is calculated using the fast fracture strength of bare specimens as the denominator. This corresponds to roughly 85% when NFS% is calculated as shown in Equation 2, where the baseline denominator is derived by subjecting bare specimens to the same incremental step load pattern used for the coated specimens.

a coating process with a NFS% above 85% does not pose any risk of causing IHE, regardless of the susceptibility of the parts being coated. Such a process is considered to be “safe”.

The test equipment used for this test was the RSL® loading frame, manufactured by Fracture Diagnostics Inc. The loading frame is a computer-controlled four-point bend, displacement control frame. It is capable of holding a displacement within ± 0.13 microns and reaching target loads within ± 0.4 pounds.

All tests were conducted in air (no applied potential) until the onset of crack growth. The duration of each test cycle ranged from 10 to 24 hours and was dependent upon the degree of embrittlement. The test specifications and protocol are as follows.

Table 16: ISL Loading Protocol for SQB Threshold Determination

Sample Type: [Notched Square Bar](#)
Loading Protocol: [16 x 5% + 15 x 2%, each at 1 hour intervals](#)
Test Type: [Bending](#)
Specimen Tensile Strength: [255 ksi](#)
Specimen Fast Fracture Load (average): [280 lbf](#)
Specimen Baseline Threshold (average): [239.3 lbf](#)
Applied Potential: [N/A](#)
Solution: [Air](#)

The ASTM F1940 test results are presented in Table 17 and Figure 23. Note that the average fracture load for the blank uncoated specimens was 239 lbs. This value was used as the baseline fracture strength.

The DACROMET® results showed a marginal reduction of NFS%, to 92-94%. This was caused by a reduction of fracture load, but was not related to hydrogen embrittlement phenomena. It is explained by a parallel reduction of specimen hardness caused by the curing cycles. The curing temperature of 610°F exceeded the tempering temperature of the specimens, which was 425°F. The resulting hardness was 48 HRC instead of 50 HRC originally. The marginally lower specimen hardness consequently lowered the fracture load. Notwithstanding this observation, the results demonstrated that the DACROMET® process poses no risk of IHE. SQB specimen hardness results measured after coating are illustrated in Figure 24.

With respect to the other coatings, the results clearly show a significant loss of fracture strength for all specimens that were hot dip galvanized, with NFS% values ranging from 41 to 45%. These values attest to a high degree of embrittlement. More significantly the elimination of acid pickling did not result in any significant improvement of fracture strength. It should be noted that the drop in fracture strength was also accompanied by drop in hardness to roughly 45 HRC resulting

from exposure to the 845°F temperature of the galvanizing kettle. However this alone does not explain the drop in fracture strength since the fracture surface morphology was predominantly brittle (Ref 3). The fracture strength of TMP Batch 4 specimens, which were only exposed to heat, was unaffected. These results and their significance with respect to hot dip galvanizing are detailed in IBECA Technologies Research Report 05-01 (Ref 3).

The mechanical galvanizing results showed no lowering of NFS%, demonstrating that the process poses no risk of IHE. Also, SQB specimen hardness values were not altered by the coating cycle.

Table 17: Summary ASTM F1940 Test Results

Specimen Designation	Mean ISL Fracture Load (lbs)	Std Dev	Mean NFS%
DACROMET®	222	3.35	93%
HDG	103	17.9	43%
HEAT ONLY	244	5.3	102%
MG	245.50	0.80	103%
Blank	239	2.5	100%

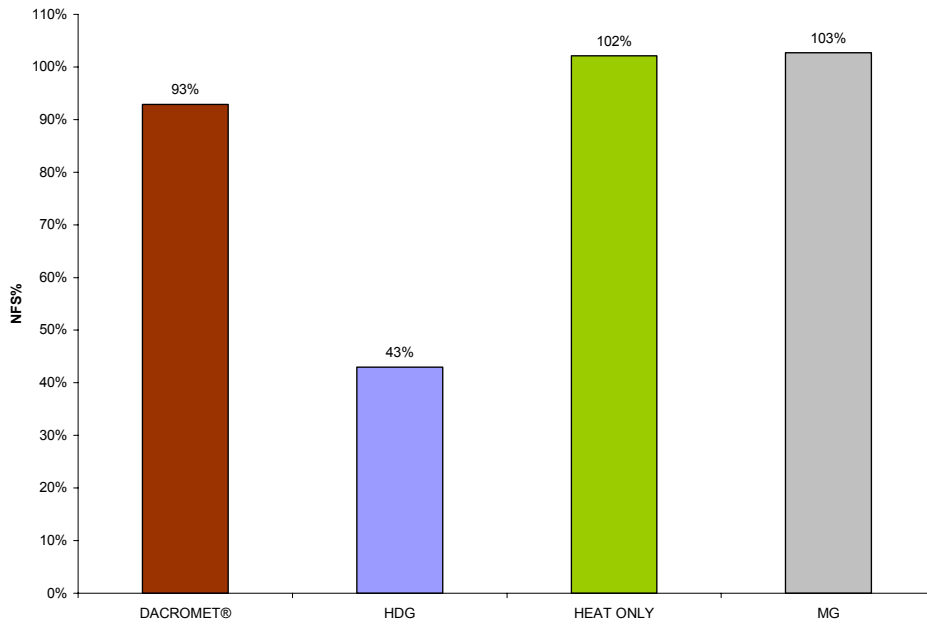

Figure 23: Summary ASTM F1940 Test Results

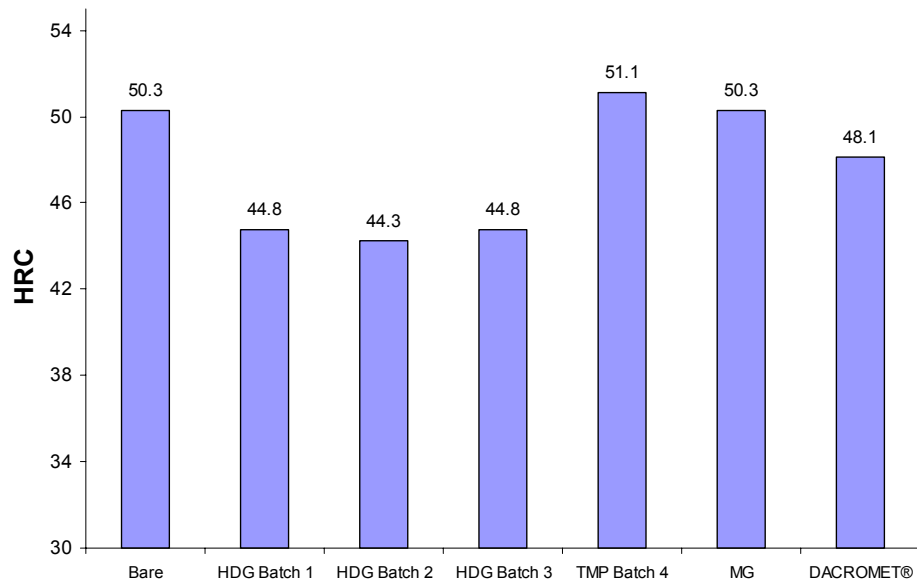

Figure 24: Hardness of Coated SQB Specimens

5. SYNOPSIS

The tests conducted during this investigation were designed to qualify DACROMET® for use with high strength A490 bolts by evaluating its performance in three distinct areas; (i) coating characteristics, (ii) corrosion performance, and (iii) hydrogen embrittlement. A synopsis of the results obtained is as follows.

5.1 COATING CHARACTERISTICS

These tests were conducted on the standard A490 bolts manufactured by Saint-Louis Screw & Bolt Company (SL_{std}).

Coating thickness and uniformity – the average coating thickness of DACROMET® coated bolts, measured per ASTM D1186, was approximately 9 microns, which is roughly one tenth that of hot dip galvanized bolts and seven times less than that of mechanical galvanized bolt. This thinner coating eliminates the need for increasing the basic coating allowance between mating threads. The requirement for oversized nuts or in some cases undersized bolt threads is an added manufacturing and procurement complication that is best avoided. DACROMET® also presents a smooth and uniform coating which enhances ease of installation.

Paintability – this is an important application requirement because structural bolts are typically assembled and painted along with the structure into which they have been assembled. Any metallic coating applied to the fastener must allow for the application of structural paint. The paintability and paint adherence for DACROMET®, evaluated visually and per ASTM D3359, both before and after salt spray exposure were satisfactory.

Coating adhesion – adhesion of a coating to the steel substrate is an inherent characteristic of its bonding mechanism, but is also a function of adequate cleaning and surface preparation for a given coating process. DACROMET® coating tested per ASTM B571 demonstrated excellent adhesion, obtained as a result of the curing step.

Lubricity – the rotational capacity test specified in ASTM A325 is designed to ensure that coated bolt/nut/washer assemblies are sufficiently lubricated to meet the tightening to yield requirement specified in RCSC's structural bolting standard (Ref. 2), without causing excessive torsional stress or failure. This test method was specifically instituted for hot dip zinc coated A325 bolts due to the high surface roughness of hot dip galvanized fasteners. Rotational capacity test results of DACROMET® P and DACROMET® XL coating systems demonstrated the lubricity

of these coating systems by easily meeting the test requirements with an average K factor of 0.1. Controlled lubricity can be considered one of the strong suites of the DACROMET® coating system which was originally designed to meet the strict surface property requirements typically specified in the automotive industry, where fasteners are robotically installed within very narrow tightening tolerances.

5.2 CORROSION PERFORMANCE

Continuous salt spray exposure – after 1000 hours of exposure, per ASTM B117 no red rust was observed on DACROMET® coated parts, whereas significant surfaces of hot dip and mechanical galvanized bolts exhibited approximately 8.5% and 85% red rust respectively. After 5000 hours of exposure, the DACROMET® coated bolts exhibited approximately 6% red rust on significant surfaces. Hot dip and mechanical galvanized bolts exhibited approximately 70% and 100% red rust respectively. Salt spray test results illustrated the superior corrosion performance of DACROMET® in comparison to hot dip zinc and mechanical galvanizing.

These tests were conducted on the standard A490 bolts manufactured by Saint-Louis Screw & Bolt Company (SL_{std}).

Cyclic exposure – only DACROMET® coated bolts were subjected to cyclic exposure per GM 9540P. After 120 cycles of exposure, less than 5% red rust was observed on significant surfaces. Additionally, the parts did not experience any weight loss due to corrosion. The measured weight loss of an uncoated control bolt was in the order of 1%. The maximum standard duration of exposure stipulated in GM 9540P is 80 cycles. Subjecting the parts to 120 cycles demonstrated the capability of DACROMET® to provide excellent corrosion protection.

The tests were conducted on the high hardness A490 bolts manufactured by Lake Erie Products (LE_{spe}).

5.3 HYDROGEN EMBRITTLEMENT

Product testing – slow strain rate (SSR) testing at a loading rate of 5,000 lbf/hour for 22-24 hours until final failure was conducted on DACROMET® coated bolts following 120 cycles of cyclic exposure. Testing was performed on an axial tensile machine. The test protocol was selected in accordance with the principles of ASTM F1624, except that a continuous loading pattern was used instead of a step loading pattern. The tests were conducted on high hardness A490 bolts manufactured by Lake Erie Products (LE_{spe}). The bolts had undergone exposure under near-yield applied stress (turn-of-nut tightened), and without any applied stress (finger tightened). The test conditions were designed to simulate a “worst case” scenario for stress corrosion cracking (SCC) by maximizing the primary risk factors, i.e. material susceptibility, corrosive environment, and applied stress. The purpose of

the test was to determine if the ductility and strength of the bolts had decreased from the baseline values. Any significant decrease would be an indication that SCC related material degradation and microcracking had begun. Another area of concern was the possibility that a difference in the corrosion potential and corrosion current between coating and base steel, if significant, could lead to increased amounts of corrosion-generated hydrogen being absorbed into the material. This phenomenon is known as cathodic hydrogen absorption (CHA). It should be noted that the corrosion potential/current difference was not specifically measured. So it was not clear at the outset if this would in fact be an aggravating factor.

The test results showed no loss in SSR strength for DACROMET® coated bolts. In comparison, uncoated bolts that were exposed under applied stress did experience a marginal drop in SSR strength³. Based on these results, the following conclusions can be drawn.

- a. The selected test protocol was sensitive enough to detect even a marginal drop in strength.
- b. Even at the excessive hardness of approximately 40 HRC the LE_{spe} bolts were not very susceptible to HE assisted failure.
- c. CHA was evidently not a factor. Although corrosion potential and corrosion current were not measured, it is likely that the presence of aluminum and chromium in the DACROMET® formulation makes it significantly less sacrificial than pure zinc, used in hot dip zinc and mechanical galvanizing. What is certain is that under “worst case” simulated application conditions, CHA is not a significant risk factor for DACROMET® coated A490 structural bolts.

Process qualification – coating process qualification was conducted using notched square bar specimens (SQB), in accordance with ASTM F1940. The results demonstrated that DACROMET® and mechanical galvanizing do not cause any internal hydrogen embrittlement (IHE). Comparatively, hot dip galvanizing resulted in significant embrittlement, even in the absence of pickling as the sole source of any process generated hydrogen.

At the heart of the prohibition against metallic coatings on ASTM A490 high strength structural bolts, was the desire to institute a measure that would eliminate the risk of hydrogen embrittlement. The catalyst for the prohibition was Townsend’s report in

³ The single data point does not allow for a definitive observation regarding the lower fracture strength of BARE bolts exposed under load. Indeed no evidence of brittle intergranular morphology was found during SEM analysis of the fracture surface.

1975 (Ref. 1). The primary coating targeted by the prohibition was hot dip zinc, since it has been the coating of choice for structural fastening applications.

The poor IHE results obtained for hot dip galvanizing are quite significant, in that they at least partially explain Townsend's findings. He concluded that there was a substantial risk of hydrogen embrittlement failure from zinc coatings, and in particular hot dip galvanized coatings. His findings were partly due to the sacrificial nature of zinc and resulting cathodically generated hydrogen (CHA), and partly due to process generated hydrogen such as through acid pickling and electroplating. However, in the case of hot dip galvanizing there may be another factor at play. It is plausible that the thermal shock from hot-dipping can result in previously trapped hydrogen to be released and migrate towards grain boundaries, where it can cause severe hydrogen embrittlement (Ref. 3).

6. CONCLUSIONS

This investigation has shown that IFI-144 can serve as a testing roadmap for qualifying “safe” metallic coatings for use with high strength structural fasteners.

DACROMET® coating systems satisfied all of the performance criteria specified in IFI-144, including paintability, coating adhesion, and rotational capacity. Continuous salt spray and cyclic exposure demonstrated that DACROMET® has significantly superior corrosion performance as compared to hot dip zinc and mechanical galvanizing.

Process qualification results and product testing results demonstrated that DACROMET® does not cause internal hydrogen embrittlement (IHE), nor does it promote environmental hydrogen embrittlement (EHE) when used on ASTM A490 high strength structural bolts. This is the single most significant finding of this investigation, since it addresses the primary concern that led to the prohibition against metallic coatings on ASTM A490 high strength structural bolts in the first place.

Based on the findings of this investigation it can be safely concluded that DACROMET® satisfied both the letter and the intent of IFI-144.

ACKNOWLEDGEMENTS

Andrew Pfeifer and Metal Coatings International are to be thanked and commended for their vision in taking on the challenge to commission and carry out this project. This was the first study of its kind to use IFI-144 as a methodology to qualify metallic coatings for use on high strength structural fasteners.

The following individuals and organizations are also to be thanked for their support in implementing this project.

Charlie Wilson - Industrial Fasteners Institute (IFI)

Steve Vass - Chairman, IFI Structural Bolting Subcommittee

Mike Friel, Steve Pitts, Tony Morales - Haydon Bolts, Inc.

Garland Parker - St. Louis Screw & Bolt

Mike Gaydos - Stork Herron Testing Laboratories

Christa Shirey - National Exposure Testing

Steve Doyle, Mike Lentz - Michigan Metal Coatings Company

Jean-Claude Legault, Abdlehaq el-Ouardi, Gabriel Landry - Infasco

Steve Quinn, Bob Hohn - Allegheny Coatings

Gerald Schroeder - Federal Highway Administration

Karl Frank - University of Texas at Austin

Pete Birkemoe - University of Toronto

Geoff Kulak - University of Alberta

Gene Mitchell

Bess Industries - Doug Bess

John Dutton, Terry Dorsett, MJ Klimowski, Kelli Leonetti, Victor Lam - Metal Coatings International Inc.

REFERENCES

1. Townsend, H.E., *Effects of Zinc Coatings on the Stress Corrosion Cracking and Hydrogen Embrittlement of Low-Alloy Steel*, Metallurgical Transactions, Volume 6A, April 1975
2. RCSC – *Specification for Structural Joints Using ASTM A325 or A490 Bolts*, June 23, 2000.
3. Brahim, S., *ASTM F1940 Testing of Hot Dip Galvanizing Processes*, January, 2005.

REFERENCED STANDARDS

1. IFI-144 *Test Evaluation Procedures for Coating Qualification Intended for Use on High-Strength Structural Bolts.*
2. GM 9540P *Accelerated Corrosion Test.*
3. ASTM A 153 *Zinc Coating (Hot-Dip) on Iron and Steel Hardware*
4. ASTM A325 *Standard Specification for Structural Bolts, Steel, Heat Treated, 120/105 ksi Minimum Tensile Strength*
5. ASTM A 490 *Standard Specification for Structural Bolts, Alloy Steel, Heat Treated, 150 ksi Minimum Tensile Strength*
6. ASTM A 751 *Test Methods, Practices, and Terminology for Chemical Analysis of Steel Products*
7. ASTM B117 *Standard Practice for Operating Salt Spray (Fog) Apparatus*
8. ASTM B 571 *Standard Practice for Qualitative Adhesion Testing of Metallic Coatings*
9. ASTM B 695 *Coatings of Zinc Mechanically Deposited on Iron and Steel*
10. ASTM D1186 *Standard Test Methods for Nondestructive Measurement of Dry Film Thickness of Nonmagnetic Coatings Applied to a Ferrous Base*
11. ASTM D 1654 *Standard Test Method for Evaluation of Painted or Coated Specimens Subjected to Corrosive Environments*
12. ASTM D 3359 *Standard Test Methods for Measuring Adhesion by Tape Test*
13. ASTM E 3 *Practice of Preparation of Metallographic Specimens*
14. ASTM E8 *Test Methods for Tension Testing of Metallic Materials.*
15. ASTM E92 *Standard Test Method for Vickers Hardness of Metallic Materials*
16. ASTM F 606 *Test Methods for Determining the Mechanical Properties of Externally and Internally Threaded Fasteners, Washers, and Rivets*
17. ASTM F1136 *Chromium/Zinc Corrosion Protective Coatings for Fasteners*
18. ASTM F 1624 *Standard Test Method for Measurement of Hydrogen Embrittlement in Steel by the incremental Loading Technique.*
19. ASTM F 1940 *Standard Test Method for Process Control Verification to Prevent Hydrogen Embrittlement in Plated or Coated Fasteners.*

APPENDICES

APPENDIX A: HOT DIP GALVANIZING

Hot-dip galvanizing is the process of applying a zinc coating to fabricated iron or steel material by immersing the material in a molten zinc bath. The galvanizing process consists of surface preparation followed by zinc immersion.

Surface preparation typically consists of three steps: (i) degreasing and caustic descaling, (ii) acid pickling or abrasive cleaning, and (iii) fluxing which removes oxides and prevents further oxides from forming on the surface of the metal prior to galvanizing. It also promotes bonding of the zinc to the steel.

Following surface preparation, the parts are completely immersed in a bath consisting of molten zinc (~ 98% Zn, 1% Pb, 0.01% Al). The bath temperature is maintained at about 450°C (845° F). Parts are immersed in the bath long enough (~ 3-5 minutes) until they reach bath temperature. This process is also referred to as 'cooking'. The articles are withdrawn slowly and the excess zinc is removed by draining, vibrating and/or centrifuging. Small parts such as fasteners are transported into the zinc bath by means of a perforated metal basket, and are typically cooled in water immediately after withdrawal from the bath. Large articles are typically cooled in ambient air.

During galvanizing, the molten zinc reacts with the surface of the steel part to form a series of successive layers composed of zinc/iron alloy phases. These layers provide excellent bond strength. Figure 1 illustrates the hardness of each layer, expressed by a Diamond Pyramid Number (DPN). Typically, the Gamma, Delta and Zeta layers are harder than the underlying steel. The Eta layer is quite ductile, providing the coating with impact resistance. The galvanized coating is adherent to the underlying steel on the order of several thousand pounds per square inch (psi). By contrast other coatings have adhesion rated at several hundred psi.

Factors influencing the thickness and appearance of the galvanized coating include chemical composition of the steel, steel surface condition, bath temperature, bath immersion time, bath withdrawal rate, and steel cooling rate.

As the galvanizing reaction is a diffusion process, higher zinc bath temperatures and longer immersion times will produce heavier alloy layers. Like all diffusion processes, the reaction proceeds rapidly at first and then slows as layers grow and become thicker. However, continued immersion beyond a certain time will have little effect on further coating growth. When galvanizing reactive steels, the diffusion process proceeds at a faster rate, producing thicker coatings.

Galvanized coatings are impermeable, and if damaged will continue to provide cathodic protection to the exposed steel. The coating coverage by this process is rough and dull. Coating in recesses such as internal socket drives and internal threads, where zinc has a tendency to accumulate, can be problematic.

Hot dip galvanizing coating standards for fasteners are specified in ASTM F2329.

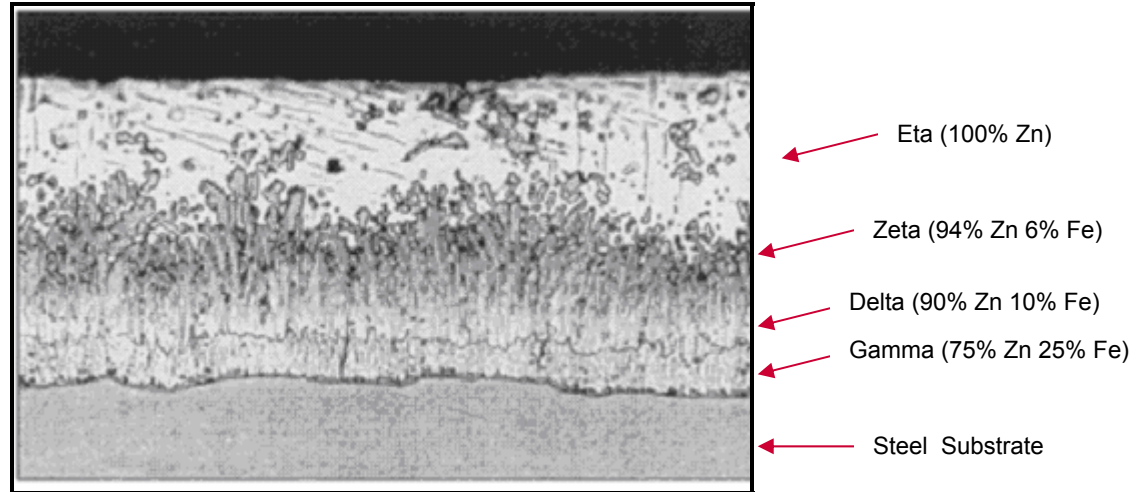

Figure A1: Microstructure of Hot-Dip Zinc Coating Illustrating Successive Zn/Fe Phases

APPENDIX B: MECHANICAL GALVANIZING

Mechanical plating and mechanical galvanizing applies a zinc coating by impaction of particulate zinc in a liquid medium filled with glass beads. The process is preceded by surface preparation.

The process begins by loading parts into a rubber lined tumbler. Surface preparation typically consists of degreasing and caustic descaling, followed by pickling in a dilute acid. Following surface preparation, varying sizes of glass beads are added along with water and 'chemical starter' which ensures an optimal chemical balance for the coating process. Next, a small quantity of copper sulfate is added to the now rotating tumbler barrel, producing a copper flashover which will act as active substrate for the zinc coating. Very fine zinc powder is then added to the process. The forces exerted by the tumbling action cause the impact media (glass beads ~1-10mm) to cold weld the much smaller and softer zinc particles (~3-5 microns) onto the surface of the parts.

The desired coating thickness is achieved by controlling the quantity of zinc powder and tumbling time. Typical coating thickness can range from 5 to 12 microns, for mechanical plating, and 25 to 110 microns for mechanical galvanizing. The coating coverage by this process is smooth and uniform, albeit porous. Good coverage may be obtained in recesses such as internal socket drives by controlling the size mix of beads. Once the correct thickness has been achieved, the parts are magnetically separated from the media and dried in a centrifuge dryer.

The principal driving force behind the development of mechanical galvanizing was the ability to coat parts with minimal risk of internal hydrogen embrittlement. From the perspective of IHE avoidance, this process offers a number of advantages to zinc plating and hot dip galvanizing. First, the process is at room temperature, thus avoiding the thermal impact of hot dip galvanizing on hydrogen mobility. Second, since the process does not involve electroplating, there is no cathodic generation of hydrogen in contact with the metal being co-deposited. Hydrogen is evolved primarily from the reaction of the mildly acidic medium with the surface of the metal. This reaction occurs at a slower rate than during electroplating. The cold welding of the relatively large zinc particles does not tend to trap hydrogen gas during impaction. Third the coating itself is less dense and more porous than zinc plating or galvanizing. Fourth, the abrasive nature of mechanical galvanizing precludes the need for aggressive acid pickling. The metal surface is cleaned by the glass beads as the coating is being deposited.

Mechanical galvanizing coating standards are specified in ASTM B695.

APPENDIX C: HARDNESS - BOLTS**Table A1: Vickers Macro Hardness - 5 Kgf**

Indentation	SL std			LE spe		
	Center	Mid Rad	Outer	Center	Mid Rad	Outer
	Sample 1			Sample 1		
1	354.7	350.9	375.9	362.0	418.7	425.2
2	350.9	361.4	361.6	425.5	424.7	428.5
3	352.8	373.3	389.7	400.0	433.0	414.4
4	365.6	372.5	371.7	420.6	399.0	405.8
5	353.1	379.4	383.3	420.7	413.0	415.1
Sample Avg.	355.4	367.5	376.4	405.8	417.7	417.8
Std. Dev.	5.849	11.325	10.792	26.369	12.805	9.112
% Std. Dev.	1.65%	3.08%	2.87%	6.50%	3.07%	2.18%
	Sample 2			Sample 2		
1	354.2	374.3	373.1	400.4	427.2	391.0
2	362.9	383.3	371.6	403.9	412.1	425.0
3	357.7	372.6	371.6	396.4	409.1	436.7
4	354.2	369.4	362.6	390.0	413.0	438.1
5	359.8	360.0	373.0	400.9	385.8	409.7
Sample Avg.	357.8	371.9	370.4	398.3	409.4	420.1
Std. Dev.	3.739	8.427	4.409	5.363	14.951	19.865
% Std. Dev.	1.05%	2.27%	1.19%	1.35%	3.65%	4.73%
	Sample 3			Sample 3		
1	355.4	358.3	348.2	399.6	415.1	403.7
2	344.7	330.1	348.2	421.2	413.2	375.8
3	342.8	348.1	367.7	397.4	417.2	410.1
4	342.7	346.0	362.2	412.0	408.8	398.8
5	347.4	363.5	351.1	408.7	423.4	421.3
Sample Avg.	346.6	349.2	355.5	407.8	415.5	401.9
Std. Dev.	5.276	12.880	8.940	9.662	5.377	16.865
% Std. Dev.	1.52%	3.69%	2.51%	2.37%	1.29%	4.20%
Lot Avg.	353.3	362.9	367.4	404.0	414.2	413.3
Avg. Std. Dev.	5.885	12.046	10.786	4.982	4.276	9.888
Avg % Std. Dev.	1.67%	3.32%	2.94%	1.23%	1.03%	2.39%
Converted to HRC Scale	35.0	36.0	36.5	39.5	40	40.4

Table A2: Rockwell C - Mid Radius - 150 Kgf

	SL std			LE spe		
	Sample 1	Sample 2	Sample 3	Sample 1	Sample 2	Sample 3
Indentation						
1	33.5	37.3	34.2	36.7	37.0	38.2
2	34.9	34.3	33.9	39.7	37.4	37.0
3	35.0	35.5	31.9	37.4	36.5	38.0
4	34.3	34.5	33.4	38.4	35.3	38.8
Sample Avg.	34.4	35.4	33.4	38.1	36.6	38.0
Std. Dev.	0.690	1.371	1.021	1.303	0.911	0.748
% Std. Dev.	2.00%	3.87%	3.06%	3.42%	2.49%	1.97%
Lot Avg.		34.4			37.5	
Avg. Std. Dev.		1.025			0.852	
Avg % Std. Dev.		2.98%			2.27%	

APPENDIX D: HARDNESS - NOTCHED SQUARE BARS**Table A3: Rockwell C Hardness Data**

Specimen Designation	Specimen ID	1	2	3	4	5	Mean	Std Dev	Corrected Value
Blank	EA 003	46.2	49.6	49.8	50.1	49.4	49.0	1.6	50.3
HDG Batch 1	EA 033	43.0	43.0	43.8	43.7	43.9	43.5	0.4	44.8
HDG Batch 2	EA 036	42.2	42.5	43.0	43.8	43.3	43.0	0.6	44.3
HDG Batch 3	EA 039	43.3	43.9	43.2	43.9	43.0	43.5	0.4	44.8
TMP Batch 4	EA 059	50.0	50.4	50.1	50.0	48.5	49.8	0.7	51.1
MG	EA 050	48.7	49.0	48.8	49.5	49.0	49.0	0.3	50.3
DAC	EA 042	47.0	47.0	47.0	47.1	46.0	46.8	0.5	48.1
ZNB	CA 0255	51.9	51.8	51.8	52.1	51.9	51.9	0.1	53.2
ZN24	CA 0251	50.2	50.0	50.5	49.5	50.1	50.1	0.4	51.4
Standard	49.3 HRC	47.2	48.0	48.8	47.8	48.0	48.0	0.6	

Table A4: Vickers 5Kg Hardness Data

Specimen Designation	Specimen ID	1	2	3	4	5	Mean	Std Dev	Converted to HRC
Blank	EA 003	494.3	481.7	489.4	482.9	464.6	482.6	11.3	48.2
HDG Batch 1	EA 033	404.4	393.5	380.8	395.3	402.2	395.2	9.3	40.5
HDG Batch 2	EA 036	404.9	406.5	406.4	400.9	393.8	402.5	5.4	41.4
HDG Batch 3	EA 039	420.4	407.9	410.6	413.9	413.4	413.2	4.7	42.5
TMP Batch 4	EA 059	499.7	494.1	478.3	483.8	487.2	488.6	8.4	48.2
MG	EA 050	474.7	485.9	494.2	477.2	485.3	483.5	7.8	47.7
DAC	EA 042	445.7	437.7	448.7	450.5	446.7	445.9	4.9	45.1
ZNB	CA 0255	502.1	509.0	515.3	506.1	515.8	509.7	5.9	49.8
ZN24	CA 0251	480.6	488.3	484.5	484.8	478.8	483.4	3.7	47.8
Averages		458.5	456.1	456.5	455.0	454.2			

APPENDIX E: COATING THICKNESS - BOLTS

Table A5: DACROMET® Bolt Coating Thickness

	Readings (mil)										Avg	Std Dev	% Std D
	1	2	3	4	5	6	7	8	9	10			
Bolt 1	0.81	0.44	0.41	0.49	0.46	0.33	0.39	0.28	0.49	0.22	0.43	0.162	37.4%
Bolt 2	0.24	0.24	0.16	0.41	0.27	0.46	0.15	0.30	0.38	0.20	0.28	0.107	37.8%
Bolt 3	0.21	0.34	0.23	0.36	0.18	0.29	0.52	0.29	0.35	0.42	0.32	0.102	32.1%
Bolt 4	0.28	0.21	0.48	0.62	0.26	0.46	0.38	0.51	0.60	0.43	0.42	0.140	33.3%
Bolt 5	0.84	0.33	0.66	0.18	0.15	0.26	0.15	0.21	0.34	0.64	0.37	0.247	65.9%
	Batch Values										0.37	0.151	41.4%

	Readings (µm)										Avg	Std Dev	% Std D
	1	2	3	4	5	6	7	8	9	10			
Bolt 1	20.7	11.1	10.4	12.5	11.6	8.3	9.9	7.1	12.5	5.6	11.0	4.11	37.4%
Bolt 2	6.2	6.1	4.1	10.4	6.8	11.7	3.8	7.6	9.8	5.0	7.2	2.71	37.8%
Bolt 3	5.4	8.6	5.8	9.0	4.6	7.3	13.2	7.3	8.9	10.6	8.1	2.59	32.1%
Bolt 4	7.1	5.2	12.1	15.6	6.5	11.6	9.7	12.9	15.2	10.9	10.7	3.55	33.3%
Bolt 5	21.3	8.3	16.8	4.6	3.9	6.6	3.7	5.2	8.6	16.2	9.5	6.27	65.9%
	Batch Values										9.3	3.84	41.4%

Thickness testing conducted to ASTM D1186

Table A6: Hot Dip Galvanizing Bolt Coating Thickness

		Readings (mil)										Avg	Std Dev	% Std D
		Bolt 1	Bolt 2	Bolt 3	Bolt 4	Bolt 5	Bolt 6	Bolt 7	Bolt 8	Bolt 9	Bolt 10			
Batch 1 (3/4-10 x 2-1/2)	Head	3.48	4.47	3.68	3.31	4.25	3.38	4.08	4.92			3.95	0.579	14.7%
	Shank	2.24	4.13	1.89	4.19	3.05	2.85	4.44	2.64			3.18	0.962	30.3%
	Tip	3.27	4.02	2.62	3.55	3.78	3.15	3.43	3.16			3.37	0.430	12.7%
Batch Values											3.50	0.657	19.2%	
Batch 1 (1-8 x 5)	Head	4.46	4.72	3.62	4.11	4.39	3.15	3.59	3.62	4.48	4.24	4.04	0.511	12.6%
	Shank	3.80	5.85	3.41	3.83	4.90	3.72	2.94	5.06	3.85	3.99	4.14	0.870	21.0%
	Tip	3.00	3.36	2.86	2.70	2.11	2.75	2.55	2.41	2.56	2.90	2.72	0.344	12.6%
Batch Values											3.63	0.575	15.4%	
Batch 3 (3/4-10 x 2-1/2)	Head	2.74	2.46	2.91	3.68	2.93						2.94	0.452	15.4%
	Shank	3.41	2.97	2.38	3.66	3.02						3.09	0.488	15.8%
	Tip	3.82	3.90	4.29	5.14	3.57						4.14	0.614	14.8%
Batch Values											3.39	0.518	15.3%	
Batch 3 (1-8 x 5)	Head	3.08	3.67	3.98	4.29	3.82						3.77	0.448	11.9%
	Shank	3.86	3.61	3.80	4.14	4.33						3.95	0.286	7.2%
	Tip	3.26	2.62	2.67	3.44	4.01						3.20	0.578	18.1%
Batch Values											3.64	0.437	12.4%	
		Readings (µm)										Avg	Std Dev	% Std D
		Bolt 1	Bolt 2	Bolt 3	Bolt 4	Bolt 5	Bolt 6	Bolt 7	Bolt 8	Bolt 9	Bolt 10			
Batch 1 (3/4-10 x 2-1/2)	Head	88.4	113.5	93.5	84.1	108.0	85.9	103.6	125.0			100.2	14.71	14.7%
	Shank	56.9	104.9	48.0	106.4	77.5	72.4	112.8	67.1			80.7	24.43	30.3%
	Tip	83.1	102.1	66.5	90.2	96.0	80.0	87.1	80.3			85.7	10.91	12.7%
Batch Values											88.9	16.68	19.2%	
Batch 1 (1-8 x 5)	Head	113.3	119.9	91.9	104.4	111.5	80.0	91.2	91.9	113.8	107.7	102.6	12.97	12.6%
	Shank	96.5	148.6	86.6	97.3	124.5	94.5	74.7	128.5	97.8	101.3	105.0	22.10	21.0%
	Tip	76.2	85.3	72.6	68.6	53.6	69.9	64.8	61.2	65.0	73.7	69.1	8.73	12.6%
Batch Values											92.2	14.60	15.4%	
Batch 3 (3/4-10 x 2-1/2)	Head	69.6	62.5	73.9	93.5	74.4						74.8	11.49	15.4%
	Shank	86.6	75.4	60.5	93.0	76.7						78.4	12.38	15.8%
	Tip	97.0	99.1	109.0	130.6	90.7						105.3	15.59	14.8%
Batch Values											86.2	13.16	15.3%	
Batch 3 (1-8 x 5)	Head	78.2	93.2	101.1	109.0	97.0						95.7	11.38	11.9%
	Shank	98.0	91.7	96.5	105.2	110.0						100.3	7.26	7.2%
	Tip	82.8	66.5	67.8	87.4	101.9						81.3	14.67	18.1%
Batch Values											92.4	11.10	12.4%	

Table A7: Mechanical Galvanizing Bolt Coating Thickness

		Readings (mil)			Avg	Std Dev	% Std D
		Bolt 1	Bolt 2	Bolt 3			
Batch 1 (3/4-10 x 2-1/2)	Head	2.08	2.40	2.10	2.19	0.179	8.2%
	Shank	2.36	2.04	2.05	2.13	0.182	8.5%
	Tip	2.15	2.53	2.13	2.27	0.225	9.9%
Batch Values					2.20	0.196	8.9%
Batch 2 (1-8 x 5)	Head	2.58	2.80	2.40	2.59	0.200	7.7%
	Shank	2.71	2.49	2.45	2.55	0.140	5.5%
	Tip	2.45	2.83	2.73	2.67	0.197	7.4%
Batch Values					2.60	0.179	6.9%
		Readings (µm)			Avg	Std Dev	% Std D
		Bolt 1	Bolt 2	Bolt 3			
Batch 1 (3/4-10 x 2-1/2)	Head	52.8	61.0	53.3	55.7	4.55	8.2%
	Shank	59.9	51.8	52.1	54.6	4.62	8.5%
	Tip	54.6	64.3	54.1	57.7	5.72	9.9%
Batch Values					56.0	4.97	8.9%
Batch 2 (1-8 x 5)	Head	65.5	71.1	61.0	65.9	5.09	7.7%
	Shank	68.8	63.2	62.2	64.8	3.56	5.5%
	Tip	62.2	71.9	69.3	67.8	5.00	7.4%
Batch Values					66.2	4.55	6.9%

Measurement per ASTM B499, Magnetic Method
Apparatus: Dermatron D-3000
Torcad Feb 23, 2004

APPENDIX F: COATING THICKNESS - NOTCHED SQUARE BARS

Table A8: DACROMET® SQB Coating Thickness

	Readings (mil)			Avg	Std Dev	% Std D
	1	2	3			
Batch 1	0.35	0.31	0.28	0.31	0.035	11.2%
	0.29	0.37	0.35	0.34	0.042	12.4%
	0.29	0.37	0.28	0.31	0.049	15.7%
	Batch Values			0.32	0.042	13.1%
Batch 2	0.34	0.40	0.27	0.34	0.065	19.3%
	0.42	0.30	0.36	0.36	0.060	16.7%
	0.30	0.37	0.31	0.33	0.038	11.6%
	Batch Values			0.34	0.054	15.9%
	Readings (µm)			Avg	Std Dev	% Std D
	1	2	3			
Batch 1	8.9	7.9	7.1	8.0	0.89	11.2%
	7.4	9.4	8.9	8.6	1.06	12.4%
	7.4	9.4	7.1	8.0	1.25	15.7%
	Batch Values			8.2	1.07	13.1%
Batch 2	8.6	10.2	6.9	8.6	1.65	19.3%
	10.7	7.6	9.1	9.1	1.52	16.7%
	7.6	9.4	7.9	8.3	0.96	11.6%
	Batch Values			8.7	1.38	15.9%

Table A9: Hot Dip Galvanizing SQB Coating Thickness

	Readings (mil)						Avg	Std Dev	% Std D	
	1	2	3	4	5	6				
Batch 1	31	3.22	2.38	3.09			2.42	2.78	0.439	15.8%
	32	3.60	3.73	3.86			3.76	3.74	0.107	2.9%
	33	2.86	2.57	2.44			2.57	2.61	0.178	6.8%
	Batch Values						3.04	0.241	8.5%	
Batch 2	34	3.22	4.33	3.36	4.06	3.35	1.57	3.32	0.964	29.1%
	35	3.93	4.27	2.77	3.22	3.72	3.67	3.60	0.531	14.8%
	36	2.78	2.87	3.33	4.61	2.91	4.30	3.47	0.795	22.9%
	Batch Values						3.46	0.763	22.3%	
Batch 3	37	3.21	2.56	2.61			2.92	2.83	0.302	10.7%
	38	3.20	3.42	3.63			2.94	3.30	0.296	9.0%
	39	3.08	2.51	2.36			2.93	2.72	0.340	12.5%
	Batch Values						2.95	0.313	10.7%	
	Readings (µm)						Avg	Std Dev	% Std D	
	1	2	3	4	5	6				
Batch 1	31	81.8	60.5	78.5			61.5	70.5	11.16	15.8%
	32	91.4	94.7	98.0			95.5	94.9	2.72	2.9%
	33	72.6	65.3	62.0			65.3	66.3	4.51	6.8%
	Batch Values						77.3	6.13	8.5%	
Batch 2	34	81.8	110.0	85.3	103.1	85.1	39.9	84.2	24.48	29.1%
	35	99.8	108.5	70.4	81.8	94.5	93.2	91.4	13.49	14.8%
	36	70.6	72.9	84.6	117.1	73.9	109.2	88.1	20.19	22.9%
	Batch Values						87.9	19.38	22.3%	
Batch 3	37	81.5	65.0	66.3			74.2	71.8	7.67	10.7%
	38	81.3	86.9	92.2			74.7	83.8	7.52	9.0%
	39	78.2	63.8	59.9			74.4	69.1	8.64	12.5%
	Batch Values						74.9	7.94	10.7%	

Table A10: Mechanical Galvanizing SQB Coating Thickness

	Readings (mil)			Avg	Std Dev	% Std D	
	1	2	3				
Batch 1	48	2.15	2.24	2.12	2.17	0.062	2.9%
	49	2.37	2.27	2.44	2.36	0.085	3.6%
	50	2.25	2.20	2.37	2.27	0.087	3.8%
	Batch Values			2.27	0.078	3.4%	
Batch 2	51	2.50	2.42	2.52	2.48	0.053	2.1%
	52	2.35	2.60	2.65	2.53	0.161	6.3%
	53	2.50	2.56	2.30	2.45	0.136	5.5%
	Batch Values			2.49	0.117	4.7%	
	Readings (µm)			Avg	Std Dev	% Std D	
	1	2	3				
Batch 1	48	54.6	56.9	53.8	55.1	1.59	2.9%
	49	60.2	57.7	62.0	59.9	2.17	3.6%
	50	57.2	55.9	60.2	57.7	2.22	3.8%
	Batch Values			57.6	1.99	3.4%	
Batch 2	51	63.5	61.5	64.0	63.0	1.34	2.1%
	52	59.7	66.0	67.3	64.3	4.08	6.3%
	53	63.5	65.0	58.4	62.3	3.46	5.5%
	Batch Values			63.2	2.96	4.7%	

Measurement per ASTM B499, Magnetic Method
Apparatus: Dermitron D-3000
Torcad Feb 23, 2004

APPENDIX G: PAINTABILITY

Table A11: "X" Scribe Test Results before Salt Spray Exposure









<u>SAMPLE - A490 BOLTS / NO SST</u>		<u>RATED PER ASTM D 3359-02</u>
SAMPLE 1:		RATING: 4A
SAMPLE 2:		RATING: 3A
SAMPLE 3:		RATING: 3A
SAMPLE 4:		RATING: 3A
SAMPLE 5:		RATING: 4A

Table A12: "X" Scribe Test Results after Salt Spray Exposure

<u>SAMPLE - A490 BOLTS / AFTER SST</u>		<u>RATED PER ASTM D 3359-02</u>
SAMPLE 1:		RATING: 4A
SAMPLE 2:		RATING: 3A
SAMPLE 3:		RATING: 3A
SAMPLE 4:		RATING: 4A
SAMPLE 5:		RATING: 4A

APPENDIX H: ADHESION

Table A13: Adhesion Scribe Test Results after Salt Spray Exposure

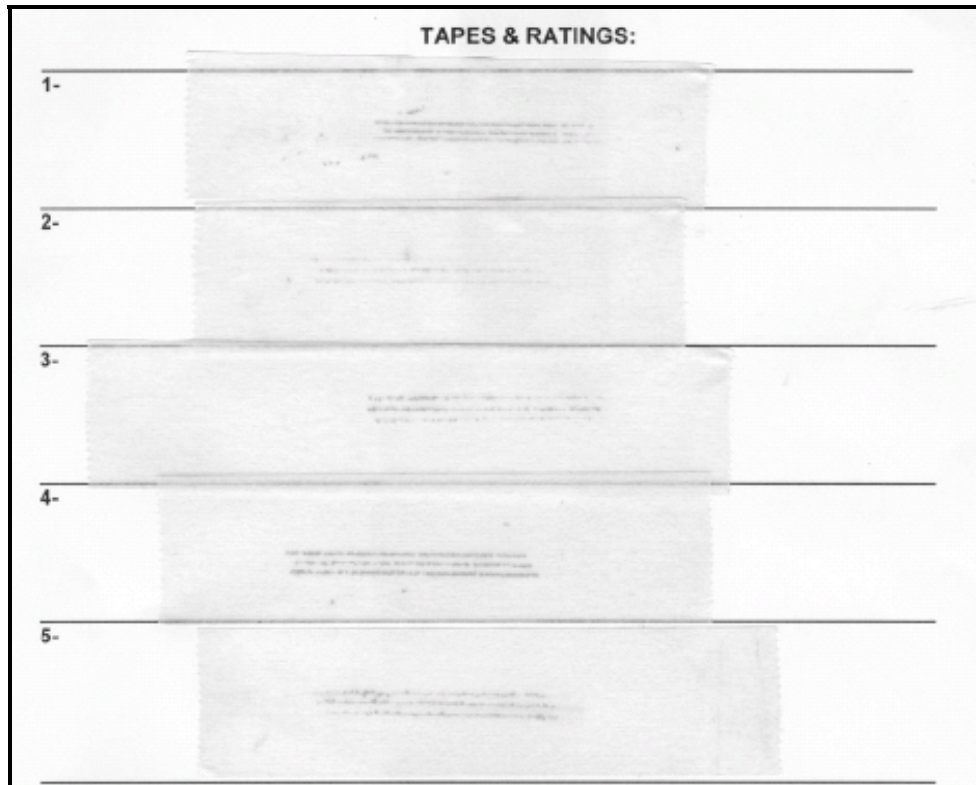

APPENDIX I: ROTATIONAL CAPACITY

Table A14: Rotational Capacity Test Results

	Tension at 180°	Torque at 180°	Coefficient of Torque	Final Tension at 363°	
	(lbf)	(ft-lbs)	$K=T/(DF)$	(lbf)	
Test 1	64,634	543	0.1008	95,612	Pass
Test 2	65,200	566	0.1042	94,554	Pass
Test 3	64,932	559	0.1033	97,551	Pass
Test 4	64,864	547	0.1012	95,965	Pass
Test 5	64,600	542	0.1007	93,322	Pass
Test 6	64,705	537	0.0996	98,078	Pass
Test 7	65,041	555	0.1024	99,225	Pass
Test 8	64,458	557	0.1037	94,644	Pass
Test 9	64,756	558	0.1034	98,865	Pass
Test 10	65,127	520	0.0958	94,058	Pass
Avg	64,832	548	0.1015	96,187	
Std Dev	243.1	13.5	0.002514	2108.3	
% Std D	0.38%	2.46%	2.48%	2.19%	

- 1 Specified minimum bolt pretension: 64,000 lbf
at nut rotation of 180° (per Table 8.1 in RCSC Specification)
- 2 Final rotational capacity nut rotation: 360° (per ASTM A325)

APPENDIX J: CONTINUOUS SALT SPRAY

Table A15: Observed Corrosion after 1000 Hours of Exposure

Set	DACROMET® P			Mechanical Galvanized			Hot Dip Galvanized		
	Bolt	Nut	Washer	Bolt	Nut	Washer	Bolt	Nut	Washer
1	0	0	0	80	5	40	10	10	25
2	0	0	0	90	20	40	10	10	40
3	0	0	0	90	30	15	5	10	50
4	0	0	0	85	15	15	5	10	40
5	0	0	0	80	30	20	10	10	20
6	0	0	0	90	15	20	10	10	20
7	0	0	0	80	30	30	10	10	10
8	0	0	0	90	20	30	10	10	20
9	0	0	0	70	25	30	5	10	10
10	0	0	0	90	20	15	10	10	10
Avg	0	0	0	84.5	21	25.5	8.5	10	24.5
Std Dev	0.00	0.00	0.00	6.85	8.10	9.85	2.42	0.00	14.23

Table A16: Observed Corrosion after 5000 Hours of Exposure

Set	DACROMET® P			Mechanical Galvanized			Hot Dip Galvanized		
	Bolt	Nut	Washer	Bolt	Nut	Washer	Bolt	Nut	Washer
1	50	Trace	Trace	100	100	100	60	100	100
2	<1	0	25	100	100	100	60	100	100
3	5	0	Trace	100	99	100	50	100	100
4	<1	0	97	100	97	100	70	100	100
5	<1	0	<1	100	95	100	70	100	100
6	<1	Trace	<1	100	100	100	80	100	100
7	<1	0	60	100	100	100	80	100	100
8	<1	Trace	<1 w/staining	100	100	100	80	100	100
9	15	Trace	100	100	100	100	80	100	100
10	<1	0	<1 w/staining	100	99	100	80	100	100
Avg	5.9	0.05	28.42	100	99	100	71	100	100
Std Dev	23.63	0.00	35.37	0.00	1.70	0.00	11.01	0.00	0.00

Values represent percentage of red rust. All HDG bolts exhibited 75-90% Red Rust with 50% of the Red Rust obscured by white corrosion product

APPENDIX K: CYCLIC TESTING

Table A17: Weight Change for Turn-of-Nut Tightened Parts

	Initial Weight					
	Bolt	Nut	W1	W2	Fixture	Asmbly
DACROMET® P	629.16	177.03	36.93	36.77	2411.0	3290.9
	628.78	176.66	36.62	36.75	2393.0	3271.8
	628.70	176.68	36.54	36.81	2416.8	3295.5
	629.34	176.80	36.88	36.87	2417.4	3297.3
	630.11	177.30	36.71	36.85	2418.1	3299.1
Control (Bare)	628.97	183.54	36.74	36.55	2414.5	3300.3
	Weight After 120 Cycles					
	Bolt	Nut	W1	W2	Fixture	Asmbly
DACROMET® P	629.20	177.01	36.95	36.79	2411.3	3291.3
	628.81	176.66	36.65	36.76	2393.2	3272.1
	628.75	176.69	36.55	36.82	2416.9	3295.7
	629.41	176.82	36.90	36.88	2417.7	3297.7
	630.20	177.32	36.73	36.88	2418.3	3299.4
Control (Bare)	618.56	174.81	33.88	34.23	2415.5	3277.0
	Weight Change					
	Bolt	Nut	W1	W2	Fixture	Asmbly
DACROMET® P	0.04	(0.02)	0.02	0.02	0.30	0.36
	0.03	0.00	0.03	0.01	0.20	0.27
	0.05	0.01	0.01	0.01	0.10	0.18
	0.07	0.02	0.02	0.01	0.30	0.42
	0.09	0.02	0.02	0.03	0.20	0.36
Avg DAC Wt. Change (g)	0.06	0.01	0.02	0.02	0.22	0.32
Bare Wt. Change (g)	(10.41)	(8.73)	(2.86)	(2.32)	1.00	(23.32)

All weights reported in grams (g)

Table A18: Weight Change for Hand Tightened Parts

	Initial Weight					
	Bolt	Nut	W1	W2	Fixture	Asmbly
DACROMET® P	629.77	176.84	38.53	38.62	2415.9	3299.7
	628.98	176.99	38.40	38.63	2415.6	3298.6
	629.38	175.25	38.33	38.96	2417.1	3299.0
	628.49	177.91	38.28	38.98	2415.1	3298.8
	628.97	178.93	38.55	38.77	2409.3	3294.5
Control (Bare)	629.13	183.48	38.56	38.13	2417.9	3307.2
	Weight After 120 Cycles					
	Bolt	Nut	W1	W2	Fixture	Asmbly
DACROMET® P	629.91	176.88	38.62	38.57	2417.5	3301.5
	629.10	177.06	38.44	38.67	2416.5	3299.8
	629.45	175.28	38.36	38.99	2418.3	3300.4
	628.53	177.96	38.30	39.01	2415.7	3299.5
	629.04	178.97	38.57	38.80	2410.0	3295.4
Control (Bare)	621.95	175.99	39.20	37.68	2418.6	3293.4
	Weight Change					
	Bolt	Nut	W1	W2	Fixture	Asmbly
DACROMET® P	0.14	0.04	0.09	(0.05)	1.60	1.82
	0.12	0.07	0.04	0.04	0.90	1.17
	0.07	0.03	0.03	0.03	1.20	1.36
	0.04	0.05	0.02	0.03	0.60	0.74
	0.07	0.04	0.02	0.03	0.70	0.86
Avg DAC Wt. Change (g)	0.09	0.05	0.04	0.02	1.00	1.19
Bare Wt. Change (g)	(7.18)	(7.49)	0.64	(0.45)	0.70	(13.78)

All weights reported in grams (g)

Table A19: Observed Corrosion at Cycle Intervals

	Sample 1	Sample 2	Sample 3	Sample 4	Sample 5	Bare
8 Cycles	0%	0%	0%	0%	0%	80%
16 Cycles	0%	0%	0%	0%	0%	80%
24 Cycles	0%	0%	0%	0%	0%	80%
32 Cycles	0%	0%	0%	0%	<1%	90%
40 Cycles	1%	<1%	0%	0%	<1%	90%
48 Cycles	1%	<1%	0%	0%	<1%	90%
56 Cycles	1%	<1%	0%	0%	<1%	90%
64 Cycles	1%	<1%	0%	0%	<1%	90%
72 Cycles	1%	<1%	0%	0%	<1%	100%
80 Cycles	1%	1%	0%	0%	<1%	100%
88 Cycles	1%	1%	0%	0%	<1%	100%
96 Cycles	1%	5%	0%	0%	<1%	100%
104 Cycles	1%	5%	0%	0%	<1%	100%
112 Cycles	1%	5%	0%	0%	<1%	100%
120 Cycles	1%	5%	0%	0%	<1%	100%

Measured Coating Thickness: 0.36 MILS (~9 MICRONS)

APPENDIX L: TENSILE STRENGTH

Table A20: Fast Fracture Tensile Strength (lbf)

(Loading Rate: 2810 lb/sec)

	Sample 1	Sample 2	Sample 3	Sample 4	Sample 5	Average	Std Dev	% Std D
SL_{std} Bare, pre-exposure	99,370	100,460	98,110			99,313	1,176	1.18%
SL_{std} DACROMET® P Post 5000 hr SST	99,010	103,100	102,930	101,480	99,190	101,142	1,969	1.95%
LE_{spe} Bare, pre-exposure	108,590	108,890	110,010			109,163	748	0.69%

APPENDIX M: HYDROGEN EMBRITTLEMENT TESTING**Table A21: Breaking Load (lbs)**

	Turn-of-nut (1/2 turn)		Finger Tightened	
	Bare	DACROMET® P	Bare	DACROMET® P
1	96,810	110,010	107,590	106,930
2		103,240		102,730
3		105,020		104,730
4		111,930		108,710
5		105,070		106,320
Avg	116,810	107,054	107,590	105,884
Std Dev		3713		2267
% Std D		3.47%		2.14%

Table A22: Percent Fracture Strength (%FS)

	Turn-of-nut (1/2 turn)		Finger Tightened	
	Bare	DACROMET® P	Bare	DACROMET® P
1	89%	101%	99%	98%
2		95%		94%
3		96%		96%
4		103%		100%
5		96%		97%
Avg	89%	98%	99%	97%
Std Dev		3.40%		2.08%

Bolt Type: **LEspe**
 Test Environment: Air
 Loading Rate: 5000 lb/hr
 Baseline Strength: 109,163 lbf

APPENDIX N: PROCESS QUALIFICATION

Table A23: ASTM F1940 Test Data

Condition	Specimen ID	Fast Fracture Strength	ISL Fracture Strength	Fracture Load	% of Fast Fracture Load	% of ISL Fracture Load
Blank	EA 001	269.89	239.3	241.1	89.3%	100.8%
Blank	EA 002	269.89	239.3	242.1	89.7%	101.2%
Blank	EA 003	269.89	239.3	237.2	87.9%	99.1%
Blank	EA 040	269.89	239.3	236.3	87.6%	98.7%
Blank	EA 041	269.89	239.3	239.7	88.8%	100.2%
HDG Batch 1	EA 031	269.89	239.3	84.1	31.2%	35.1%
HDG Batch 1	EA 032	269.89	239.3	84	31.1%	35.1%
HDG Batch 1	EA 033	269.89	239.3	126	46.7%	52.7%
HDG Batch 2	EA 034	269.89	239.3	126.1	46.7%	52.7%
HDG Batch 2	EA 035	269.89	239.3	112.2	41.6%	46.9%
HDG Batch 2	EA 036	269.89	239.3	84.1	31.2%	35.1%
HDG Batch 3	EA 037	269.89	239.3	98.1	36.3%	41.0%
HDG Batch 3	EA 038	269.89	239.3	98.1	36.3%	41.0%
HDG Batch 3	EA 039	269.89	239.3	112	41.5%	46.8%
TMP Batch 4	EA 057	269.89	239.3	248.7	92.1%	103.9%
TMP Batch 4	EA 058	269.89	239.3	238.5	88.4%	99.7%
TMP Batch 4	EA 059	269.89	239.3	246	91.1%	102.8%
MG	EA 048	269.89	239.3	245.5	91.0%	102.6%
MG	EA 049	269.89	239.3	246.5	91.3%	103.0%
MG	EA 050	269.89	239.3	246.5	91.3%	103.0%
MG	EA 051	269.89	239.3	245.7	91.0%	102.7%
MG	EA 052	269.89	239.3	243.8	90.3%	101.9%
MG	EA 053	269.89	239.3	245.5	91.0%	102.6%
DAC	EA 042	269.89	239.3	223.5	82.8%	93.4%
DAC	EA 044	269.89	239.3	217.8	80.7%	91.0%
DAC	EA 046	269.89	239.3	218.2	80.8%	91.2%
DAC	EA 043	269.89	239.3	221.7	82.1%	92.6%
DAC	EA 045	269.89	239.3	221.7	82.1%	92.6%
DAC	EA 047	269.89	239.3	227.8	84.4%	95.2%
ZNB	CA 0255	280	235	112.1	40.0%	47.7%
ZNB	CA 0260	280	235	84.8	30.3%	36.1%
ZNB	CA 0266	280	235	112	40.0%	47.7%
ZN12	CA 0252	280	235	221	78.9%	94.0%
ZN12	CA 0253	280	235	126.6	45.2%	53.9%
ZN12	CA 0265	280	235	119.6	42.7%	50.9%
ZN24	CA 0251	280	235	228.8	81.7%	97.4%
ZN24	CA 0262	280	235	223.5	79.8%	95.1%
ZN24	CA 0271	280	235	218.6	78.1%	93.0%

Note: **bold characters** indicate specimens randomly selected for testing and analysis.

